



# XPRESS COATING SYSTEM Picote Brush Coating™ System

## OPERATION, SAFETY & INSTALLATION MANUAL



### **WARNING**

*These instructions are for your personal safety. Always ensure that you have read and understood these instructions before using the equipment.*  
**SAVE THESE INSTRUCTIONS FOR FUTURE REFERENCE.**

# TABLE OF CONTENTS

SAVE ALL WARNINGS AND INSTRUCTIONS FOR FUTURE REFERENCE

TOPIC	PAGE
Safety Information	3
Environmental, Transport, Storage & Disposal	5
CE Declaration of Conformity	7
Xpress Pump	10
Resin Calculator & Coating Scale	14
Xpress Hose Reel	16
Xpress Hose Reel Heating Blanket	18
Remote Control	19
Initial Setup (Installing & Charging Battery, Reel Setup, Filling & Bleeding System)	21
Picote Millers   8mm (1/3") Shaft	23
Picote Millers   10-12mm (3/8-1/2") Shaft	25
Pipe Preparation	27
Assembly: Brushes	28
Assembly: Delivery Hose & Camera	31
Resin Preparation	32
Resin Maintenance: Circulation / Re-Crystallization Process	35
System Preparation	36
Coating Process	37
System Cleaning	40
Resin Curing & Applying Additional Coats	42
Xpress 100% Solids Epoxy Resin Information	43
Maintenance	44
Parts & Accessories (US and UK/EU/ROW)	46
Troubleshooting Flowchart & Fault Codes	50
Warranty Policy & Procedure	52
Training & Certification	53

To watch practical demonstration videos, take a course, or to download an electronic copy of these Instructions, please visit [www.picoteinstitute.com](http://www.picoteinstitute.com). Please note that videos and courses are not intended as a replacement or alternative to this operating and safety manual, but only as an additional learning tool.

# SAFETY INFORMATION

SAVE ALL WARNINGS AND INSTRUCTIONS FOR FUTURE REFERENCE

## **WARNING**

This section contains important safety information.  
Failure to comply could result in serious injury or death.

### Safety Symbols

Safety symbols are used throughout this manual to draw attention to potential hazards.



**Danger** risk of serious injury, follow instructions.



**Danger** risk of serious injury or death by electrocution, follow instructions.



**Danger** risk of serious injury from moving parts, follow instructions.



**Danger** risk of serious injury from hot parts, follow instructions.



**Danger** do not touch. Risk of injury, follow instructions.

### Personal Protective Equipment (PPE)

Always use Personal Protective Equipment including suitable protective clothing, footwear, plus:



Suitable eye protection to protect against injuries and chemicals from irritating eyes.



Suitable ear protection to protect against hearing loss.



Suitable heat and cut-resistant gloves to help prevent any hand injuries. Any open injuries or skin irritations should always be covered to avoid contact with sewage, chemicals or dust.



Suitable respirator to prevent any dust or fumes being inhaled or consumed, which could cause occupational asthma or dermatitis.

# GENERAL MACHINE SAFETY INFORMATION

SAVE ALL WARNINGS AND INSTRUCTIONS FOR FUTURE REFERENCE

## WARNING

This section contains important safety information.  
Failure to comply could result in serious injury or death.

Resin SDS Sheets, please scan the QR code from the resin bucket(s) or download from the Picote Institute ([picoteinstitute.com](http://picoteinstitute.com))



1. Always wear appropriate personal protective equipment including eye, ear, and breathing protection as well as well as heat and cut-resistant gloves. Other personal protective equipment should be worn when necessary.



2. Dust produced when working can be dangerous to your health, inflammable or explosive. Ensure that the ventilation openings are kept clear when working in dusty conditions. If it should become necessary to clear dust, first unplug the machine. Avoid damaging internal parts.



3. Make sure the pipe has been opened and ventilated to prevent any gases accumulating.



4. Always ensure that the machine is fully turned off and unplugged before inspection, maintenance, or installing any accessories to the machine. Always follow the instructions in the manufacturer's manual.

5. **Before each use** inspect the machine carefully for any potential break or damage. **Change damaged parts immediately.** It is especially important to check the end of the shaft for any signs of wear and tear, and repeat the process for the outer casing.

6. When in use, it is very important that the machine is stable and on an even surface at all times.



7. **Never leave the machine running unattended.** Always hold the cable when operating the machine.

8. **Do not touch Smart Cutter™ or Grinding Chains immediately after use,** they may be hot and could burn your skin.

9. If the working environment is extremely hot, humid, or badly polluted by conductive dust, use a GFCI-enabled power outlet to ensure the safety of the operator.

10. Make sure that job location is well ventilated before grinding or drilling. Always use a vacuum extraction system in the pipe to remove dust. Operator must wear a dust mask when dry grinding to clean pipes

11. **Do not use the machine on any pipes containing asbestos fibres.**



12. **Never touch rotating parts.**

13. Do not stand on the machine.

14. Only use this machine with the accessories and spare parts offered by the Picote Solutions. Accessories and spare parts should only be used in the manner intended and as described by Picote Solutions.

15. Only operate the Miller foot pedal or OPC as instructed. Never place anything on it in place of a foot.

16. Do not extend a Miller shaft by more than one extension. Use only Picote Solutions shaft extensions and connectors.

# ENVIRONMENT, TRANSPORT, STORAGE & DISPOSAL

SAVE ALL WARNINGS AND INSTRUCTIONS FOR FUTURE REFERENCE



This section contains important safety information.  
Failure to comply could result in serious injury or death.

## ENVIRONMENTAL

- **Operational Ambient Temperature Range:** 10°C to 50°C (50-122°F) frost and condensation free
- **Storage Ambient Temperature Range:** 0°C to 50°C (32-122°F) frost and condensation free
- **Maximum Altitude:** 2000m or 6500 ft. Derate above 1000m or 3280 ft: 1% / 100m or 328 feet
- **Maximum Humidity:** 95% non-condensing
- **NOTE! When using the Xpress Coating System outside, it should be protected from the elements (rain and snow) with a suitable tent or shelter.**

## TRANSPORT

Xpress Coating Pump should be transported in a vehicle or trailer secured with ratchet straps to prevent any sudden movements or accidents caused by hard braking or accident. If transported in a laid down position, make sure the resin reservoir lids and lid plugs are securely in place to avoid spillage.

The Xpress Hose Reel should be transported in a vehicle or trailer in a laid down position secured with ratchet straps to prevent any sudden movements or accidents caused by hard braking or accident.

**Never transport Millers with tooling attached to the shaft.** On +C models, always retract the camera back to its housing during transport. Always use a suitable cover on the unit to protect the Picote Millers or Xpress Coating System from the elements when using a pick-up or trailer to transport them.

## STORAGE

It is recommended that the Xpress Coating System and Picote Millers be stored indoors to protect them from rain and sunlight, and also in a constant ambient temperature.

If the Xpress Coating System or Picote Miller has been stored in an environment colder than +10°C or 50°F, the machine should be stood at room temperature for 24 hours before use.

If the Xpress Coating System or Picote Miller has been stored for long periods of time (over 2-3 months), it should be checked and tested according to the maintenance programme before use.

Charge the Xpress Pump battery to around 80% capacity before storing for long periods.

**NEVER leave the unit unattended while it is charging.**

# ENVIRONMENT, TRANSPORT, STORAGE & DISPOSAL

SAVE ALL WARNINGS AND INSTRUCTIONS FOR FUTURE REFERENCE

## WARNING

This section contains important safety information.  
Failure to comply could result in serious injury or death.

### DISPOSAL

Xpress Coating Pump actuators, Hose Reel motor, control box, electric wires and power supply can be disposed in Europe at Waste Electrical and Electronic Equipment (WEEE) collection points.

The Xpress Coating Pump and Hose Reel frame can be recycled in metal waste collection points. Delivery and Supply Hoses, resin reservoirs and cylinders are contaminated with the resin components and should be disposed of as per local regulations if not cleaned properly.

Dispose of unused Resin by mixing the product in a well ventilated location using a non-flammable container. The mixed product will generate heat while hardening. Follow the SDS sheets which can be found on the Picote Institute ([picoteinstitute.com](http://picoteinstitute.com))

**Always follow local, regional, and national waste handling rules and regulations.**



#### **Picote Xpress 100% Solids Epoxy Resin:**

Refer to SDS for Environment, Transport, Disposal and Storage information, available from Picote Institute.



Recycle Li-ion batteries according to local regulations.

**Do not dispose of in fire! Do not puncture!**

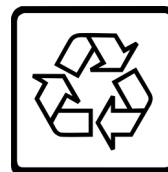

**Li-ion**



# CE DECLARATION OF CONFORMITY

**SAVE ALL WARNINGS AND INSTRUCTIONS FOR FUTURE REFERENCE**

**We Picote Solutions Oy Ltd as the responsible manufacturer, declare that the following Picote Solutions Oy Ltd machine:**

Xpress Coating Pump  
is of series production and

**Conforms to the following EU Directive:**

2006/42/EY

And is manufactured in accordance with the following standards or standardised documents:

EN ISO 13849-1

The technical documentation is kept by our authorised representative in Europe who is:

Picote Solutions Oy Ltd, Pienteollisuustie 24  
06450 Porvoo, Finland

12th October 2023



Katja Lindy-Wilkinson  
C.E.O.

Picote Solutions Oy Ltd  
Pienteollisuustie 24, 06450 Porvoo, Finland

# CE DECLARATION OF CONFORMITY

**SAVE ALL WARNINGS AND INSTRUCTIONS FOR FUTURE REFERENCE**

**We Picote Solutions Oy Ltd as the responsible manufacturer, declare that the following Picote Solutions Oy Ltd machine:**

Xpress Hose Reel

is of series production and

**Conforms to the following EU Directive:**

**2006/42/EY**

And is manufactured in accordance with the following standards or standardised documents:

**EN ISO 13849-1**

The technical documentation is kept by our authorised representative in Europe who is:

Picote Solutions Oy Ltd, Pienteollisuustie 24  
06450 Porvoo, Finland

**12th October 2023**

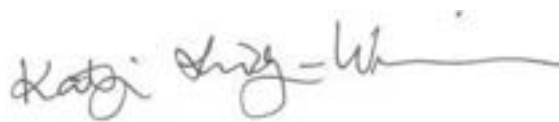

Katja Lindy-Wilkinson  
C.E.O.

Picote Solutions Oy Ltd  
Pienteollisuustie 24, 06450 Porvoo, Finland



# CE DECLARATION OF CONFORMITY

**SAVE ALL WARNINGS AND INSTRUCTIONS FOR FUTURE REFERENCE**

**We Picote Solutions Oy Ltd as the responsible manufacturer, declare that the following Picote Solutions Oy Ltd machine:**

Xpress Hose Reel Heating Blanket  
is of series production and

**Conforms to the following EU Directive:**

**2006/42/EY**

And is manufactured in accordance with the following standards or standardised documents:

**EN ISO 60335-2-17**

The technical documentation is kept by our authorised representative in Europe who is:

Picote Solutions Oy Ltd, Pienteollisuustie 24  
06450 Porvoo, Finland

**12th October 2023**

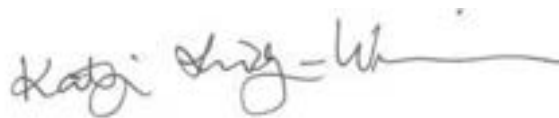

Katja Lindy-Wilkinson  
C.E.O.

Picote Solutions Oy Ltd  
Pienteollisuustie 24, 06450 Porvoo, Finland

# XPRESS COATING SYSTEM | PUMP

SAVE ALL WARNINGS AND INSTRUCTIONS FOR FUTURE REFERENCE

## General Description

1. Lubricant Reservoir
2. Resin Reservoirs (Base & Catalyst)
3. Safety Screen
4. Reservoir Valve
5. Pumping Volume Indicator
6. Cylinder
7. Actuator
8. Resin Supply Hose Connector
9. Pressure Gauge

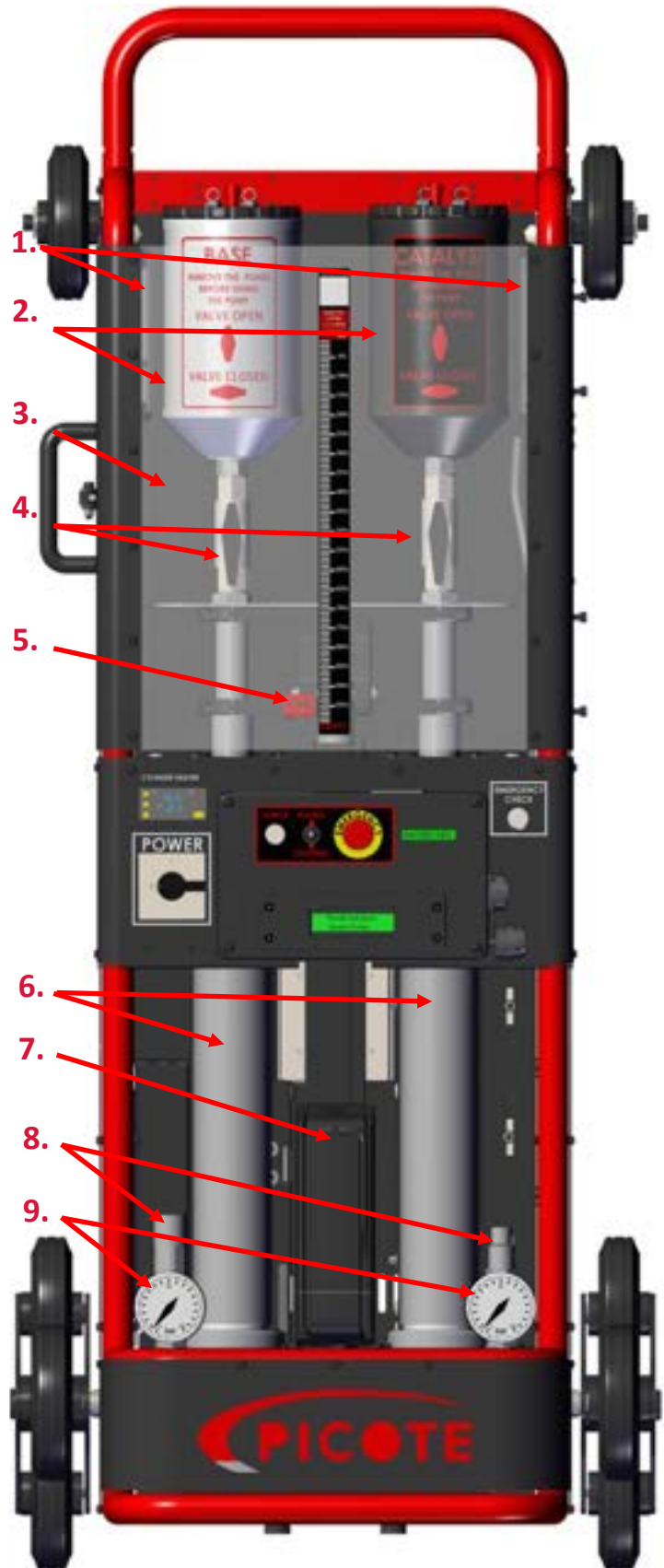

# XPRESS COATING SYSTEM | PUMP

SAVE ALL WARNINGS AND INSTRUCTIONS FOR FUTURE REFERENCE

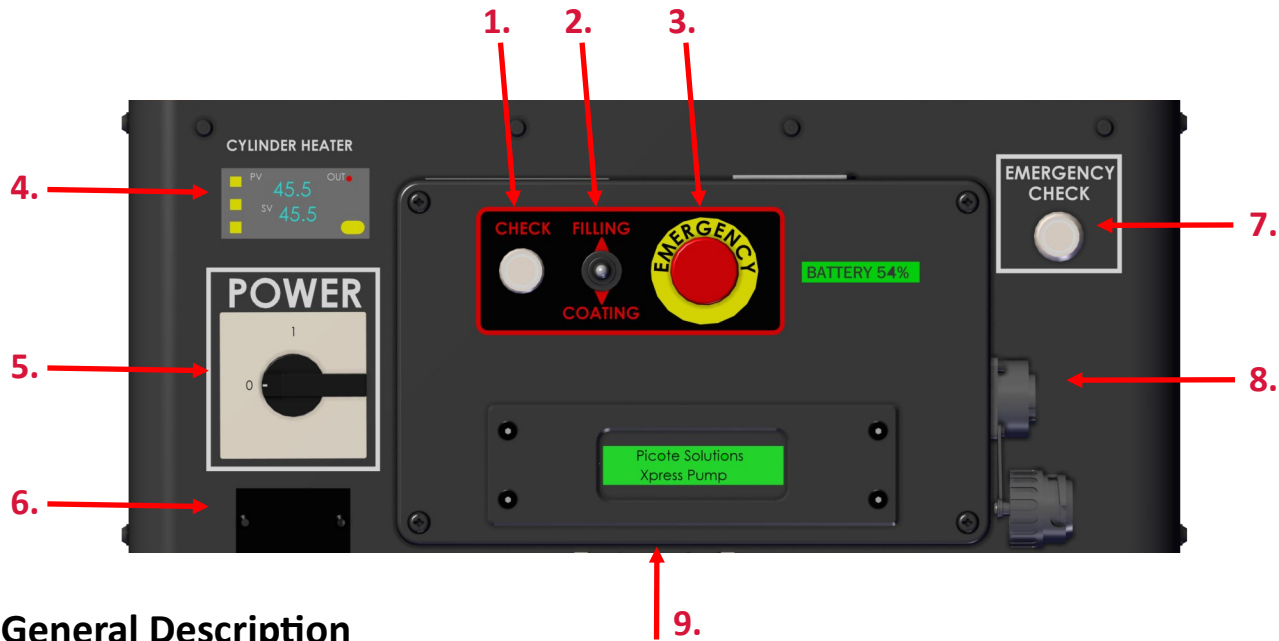

## General Description

1. Operation Check Button
2. Filling/Coating Switch
3. Emergency Stop
4. Cylinder Thermostat
5. On/Off Switch
6. Power Socket
7. Emergency Check Button
8. Hose Reel Connector
9. Pump Display

## Intended Use

This machine is intended for the following uses:

- Picote Brush Coating™ pipes from DN32-300 (1¼' - 12'') in diameter
- Always follow Manufacturer's instructions when installing and using the machine and/or accessories.

 Voltage: All variants of the Xpress Coating System operate within 90-240VAC 50/60Hz.

 Battery: The Xpress Coating Pump has an internal 48V 882Wh Li-Ion battery.

 This machine has a hand-held Start button.  
Press the button to start the Pump and then press the button again to stop the Pump.

# XPRESS COATING SYSTEM | PUMP

SAVE ALL WARNINGS AND INSTRUCTIONS FOR FUTURE REFERENCE

## Emergency Stop

On the Xpress Coating System there are a total of three Emergency Stops:

1. One on the Pump
2. One on the Hose Reel
3. One on the Remote Control

Engaging the Emergency Stop anywhere in the system will result in the system shutting down and the pump actuators will stop and the Hose Reel retraction is prevented.



**NOTE: The Xpress Pump Cylinder Heaters & Hose Reel Heating Blanket/ Heating Blanket Power Connection Outlet will still have power.**



## Emergency Check Button

If the Emergency Stop is engaged, the Safety Screen opened or the machine has just been powered up, this button needs to be pressed before the Xpress Pump can be operated.

**NOTE: If the Safety Screen has been opened, the Hose Reel can still be operated.**



## Main Power Switch & Battery Charging

The Main Power Switch is used to turn the system ON/OFF.

**NOTE: To speed up the charging turn the machine OFF.**

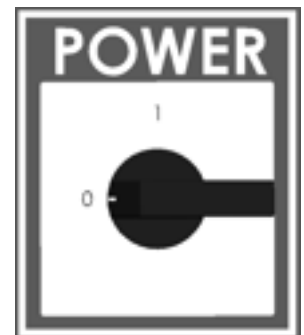

## Resin Reservoir Valves

Both Resin Reservoirs have hand operated Valves which need to be closed or opened depending on the pumping status. The valves are open when they are in the vertical and closed in the horizontal position.

When filling the cylinders: OPEN

When pumping: CLOSED

**NOTE: When pumping, the CATALYST pressure will rise before the BASE pressure.**

When starting to pump, keep the catalyst valve open and then close it as soon as the pressure starts to rise on the BASE side gauge.

**If it takes over 25mm (1") of travel to even the pressure, there might be air in the system and it should be bled before proceeding!**

*(refer to Pages 21-22 for information on the process for bleeding the system).*



# XPRESS COATING SYSTEM | PUMP

SAVE ALL WARNINGS AND INSTRUCTIONS FOR FUTURE REFERENCE

## Safety Screen

The Safety Screen is equipped with a safety hinge, which stops the pump when the screen is not in closed position. Opening the screen will cause Emergency Check to activate.



## Direction Switch

The Direction Switch is used to change the direction of the actuators:

- Upwards (FILLING) motion is used to draw more resin in to cylinder from the reservoirs.
- Downwards (COATING) motion is used to pump the resin.



## Cylinder and Hose Reel Heating

The Xpress Coating Pump cylinders and Hose Reel Blanket are heated.

- Heating thermostat has been pre-set:
  - Pump: 50°C (122°F)
  - Reel: 40°C (104°F)
- There is an indicator light *OUT* which is lit when the heating is active.
- Actual temperature is displayed in **red**.
- The set temperature is displayed in **blue**.
- To adjust temperature, shortly press **SET** and then select desired temperature with **UP** and **DOWN** buttons.



**NOTE! The resin warms up slower than the cylinders or the hose reel. It is recommended to warm up the system for at least 30 minutes (depending on the ambient temperature).**

## Check Button

Check button is used to check messages printed on the pump display. Actions that require check button to be pressed are presented with an audible beep.

Press the button firmly.

**NOTE! This button is NOT the same as the Emergency Check Button!**

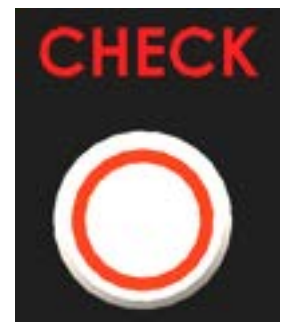

# XPRESS COATING SYSTEM | PUMP

SAVE ALL WARNINGS AND INSTRUCTIONS FOR FUTURE REFERENCE

## Pumping Volume Indicator

The Safety Screen has a Volume Indicator which shows how much of the total resin volume has been pumped from the cylinders.

Behind the Safety Screen there is a **RED** marker that moves in conjunction with the pistons. The value starts at 0% (top), which means 0% of the volume has been used (cylinders are full).

## Resin Calculator

The Picote Xpress Resin Calculator is an Excel spreadsheet that can be downloaded from the Picote Institute online learning platform at [picoteinstitute.com](http://picoteinstitute.com). It calculates project resin usage based on pipe diameter, number of coats, and repair length.

## Xpress Pump Coating Scale

You can use the Pumping Volume Indicator information along with Coating Scale Charts (also part of the downloadable Xpress Resin Calculator) to show maximum distance, by pipe diameter that the remaining resin in the cylinders will cover.



		<h2 style="margin: 0;">Xpress Coating Scale (USA)</h2>										
		Scale is the maximum distance one full stroke of the Xpress Pump will cover.										
Scale	Pipe Diameter (Inches)											
%	1 1/4"	1 1/2"	2"	3"	4"	5"	6"	8"	9"	10"	12"	
0%	88.6 ft	65.6 ft	52.5 ft	32.8 ft	26.2 ft	23.0 ft	19.7 ft	13.1 ft	11.5 ft	9.8 ft	8.5 ft	
5%	84.2 ft	62.3 ft	49.9 ft	31.2 ft	24.9 ft	21.8 ft	18.7 ft	12.5 ft	10.9 ft	9.4 ft	8.1 ft	
10%	79.7 ft	59.1 ft	47.2 ft	29.5 ft	23.6 ft	20.7 ft	17.7 ft	11.8 ft	10.3 ft	8.9 ft	7.7 ft	
15%	75.3 ft	55.8 ft	44.6 ft	27.9 ft	22.3 ft	19.5 ft	16.7 ft	11.2 ft	9.8 ft	8.4 ft	7.3 ft	
20%	70.9 ft	52.5 ft	42.0 ft	26.2 ft	21.0 ft	18.4 ft	15.7 ft	10.5 ft	9.2 ft	7.9 ft	6.8 ft	
25%	66.4 ft	49.2 ft	39.4 ft	24.6 ft	19.7 ft	17.2 ft	14.8 ft	9.8 ft	8.6 ft	7.4 ft	6.4 ft	
30%	62.0 ft	45.9 ft	36.7 ft	23.0 ft	18.4 ft	16.1 ft	13.8 ft	9.2 ft	8.0 ft	6.9 ft	6.0 ft	
35%	57.6 ft	42.7 ft	34.1 ft	21.3 ft	17.1 ft	14.9 ft	12.8 ft	8.5 ft	7.5 ft	6.4 ft	5.5 ft	
40%	53.1 ft	39.4 ft	31.5 ft	19.7 ft	15.7 ft	13.8 ft	11.8 ft	7.9 ft	6.9 ft	5.9 ft	5.1 ft	
45%	48.7 ft	36.1 ft	28.9 ft	18.0 ft	14.4 ft	12.6 ft	10.8 ft	7.2 ft	6.3 ft	5.4 ft	4.7 ft	
50%	44.3 ft	32.8 ft	26.2 ft	16.4 ft	13.1 ft	11.5 ft	9.8 ft	6.6 ft	5.7 ft	4.9 ft	4.3 ft	
55%	39.9 ft	29.5 ft	23.6 ft	14.8 ft	11.8 ft	10.3 ft	8.9 ft	5.9 ft	5.2 ft	4.4 ft	3.8 ft	
60%	35.4 ft	26.2 ft	21.0 ft	13.1 ft	10.5 ft	9.2 ft	7.9 ft	5.2 ft	4.6 ft	3.9 ft	3.4 ft	
65%	31.0 ft	23.0 ft	18.4 ft	11.5 ft	9.2 ft	8.0 ft	6.9 ft	4.6 ft	4.0 ft	3.4 ft	3.0 ft	
70%	26.6 ft	19.7 ft	15.7 ft	9.8 ft	7.9 ft	6.9 ft	5.9 ft	3.9 ft	3.4 ft	3.0 ft	2.6 ft	
75%	22.1 ft	16.4 ft	13.1 ft	8.2 ft	6.6 ft	5.7 ft	4.9 ft	3.3 ft	2.9 ft	2.5 ft	2.1 ft	
80%	17.7 ft	13.1 ft	10.5 ft	6.6 ft	5.2 ft	4.6 ft	3.9 ft	2.6 ft	2.3 ft	2.0 ft	1.7 ft	
85%	13.3 ft	9.8 ft	7.9 ft	4.9 ft	3.9 ft	3.4 ft	3.0 ft	2.0 ft	1.7 ft	1.5 ft	1.3 ft	
90%	8.9 ft	6.6 ft	5.2 ft	3.3 ft	2.6 ft	2.3 ft	2.0 ft	1.3 ft	1.1 ft	1.0 ft	0.9 ft	
95%	4.4 ft	3.3 ft	2.6 ft	1.6 ft	1.3 ft	1.1 ft	1.0 ft	0.7 ft	0.6 ft	0.5 ft	0.4 ft	
100%	0 ft	0 ft	0 ft	0 ft	0 ft	0 ft	0 ft	0 ft	0 ft	0 ft	0 ft	

# XPRESS COATING SYSTEM | PUMP

SAVE ALL WARNINGS AND INSTRUCTIONS FOR FUTURE REFERENCE

		<h2>Xpress Coating Scale (Metric)</h2>									
		Scale is the maximum distance one full stroke of the Xpress Pump will cover.									
Scale	Pipe Diameter (MM)										
%	32	40	50	70	100	125	150	200	225	250	300
0%	27.0 m	20.0 m	16.0 m	10.0 m	8.0 m	7.0 m	6.0 m	4.0 m	3.5 m	3.0 m	2.6 m
5%	25.7 m	19.0 m	15.2 m	9.5 m	7.6 m	6.7 m	5.7 m	3.8 m	3.3 m	2.9 m	2.5 m
10%	24.3 m	18.0 m	14.4 m	9.0 m	7.2 m	6.3 m	5.4 m	3.6 m	3.2 m	2.7 m	2.3 m
15%	23.0 m	17.0 m	13.6 m	8.5 m	6.8 m	6.0 m	5.1 m	3.4 m	3.0 m	2.6 m	2.2 m
20%	21.6 m	16.0 m	12.8 m	8.0 m	6.4 m	5.6 m	4.8 m	3.2 m	2.8 m	2.4 m	2.1 m
25%	20.3 m	15.0 m	12.0 m	7.5 m	6.0 m	5.3 m	4.5 m	3.0 m	2.6 m	2.3 m	2.0 m
30%	18.9 m	14.0 m	11.2 m	7.0 m	5.6 m	4.9 m	4.2 m	2.8 m	2.5 m	2.1 m	1.8 m
35%	17.6 m	13.0 m	10.4 m	6.5 m	5.2 m	4.6 m	3.9 m	2.6 m	2.3 m	2.0 m	1.7 m
40%	16.2 m	12.0 m	9.6 m	6.0 m	4.8 m	4.2 m	3.6 m	2.4 m	2.1 m	1.8 m	1.6 m
45%	14.9 m	11.0 m	8.8 m	5.5 m	4.4 m	3.9 m	3.3 m	2.2 m	1.9 m	1.7 m	1.4 m
50%	13.5 m	10.0 m	8.0 m	5.0 m	4.0 m	3.5 m	3.0 m	2.0 m	1.8 m	1.5 m	1.3 m
55%	12.2 m	9.0 m	7.2 m	4.5 m	3.6 m	3.2 m	2.7 m	1.8 m	1.6 m	1.4 m	1.2 m
60%	10.8 m	8.0 m	6.4 m	4.0 m	3.2 m	2.8 m	2.4 m	1.6 m	1.4 m	1.2 m	1.0 m
65%	9.4 m	7.0 m	5.6 m	3.5 m	2.8 m	2.5 m	2.1 m	1.4 m	1.2 m	1.1 m	0.9 m
70%	8.1 m	6.0 m	4.8 m	3.0 m	2.4 m	2.1 m	1.8 m	1.2 m	1.1 m	0.9 m	0.8 m
75%	6.7 m	5.0 m	4.0 m	2.5 m	2.0 m	1.8 m	1.5 m	1.0 m	0.9 m	0.8 m	0.7 m
80%	5.4 m	4.0 m	3.2 m	2.0 m	1.6 m	1.4 m	1.2 m	0.8 m	0.7 m	0.6 m	0.5 m
85%	4.0 m	3.0 m	2.4 m	1.5 m	1.2 m	1.1 m	0.9 m	0.6 m	0.5 m	0.5 m	0.4 m
90%	2.7 m	2.0 m	1.6 m	1.0 m	0.8 m	0.7 m	0.6 m	0.4 m	0.4 m	0.3 m	0.3 m
95%	1.3 m	1.0 m	0.8 m	0.5 m	0.4 m	0.4 m	0.3 m	0.2 m	0.2 m	0.2 m	0.1 m
100%	0 m	0 m	0 m	0 m	0 m	0 m	0 m	0 m	0 m	0 m	0 m

## Pump Display

The display on the XPRESS Pump will show current program status, gives advice and show's error messages. For example "Release the Start Button" or "Direction Changed".

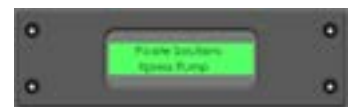

## Lubricant Reservoir

The pump cylinders are lubricated and both cylinders have their own lubricant reservoirs. The oil level should be below **MAX OIL LEVEL** label when the machine has been driven to upper position. The oil level will momentarily drop when pumping.



# XPRESS COATING SYSTEM | HOSE REEL

SAVE ALL WARNINGS AND INSTRUCTIONS FOR FUTURE REFERENCE

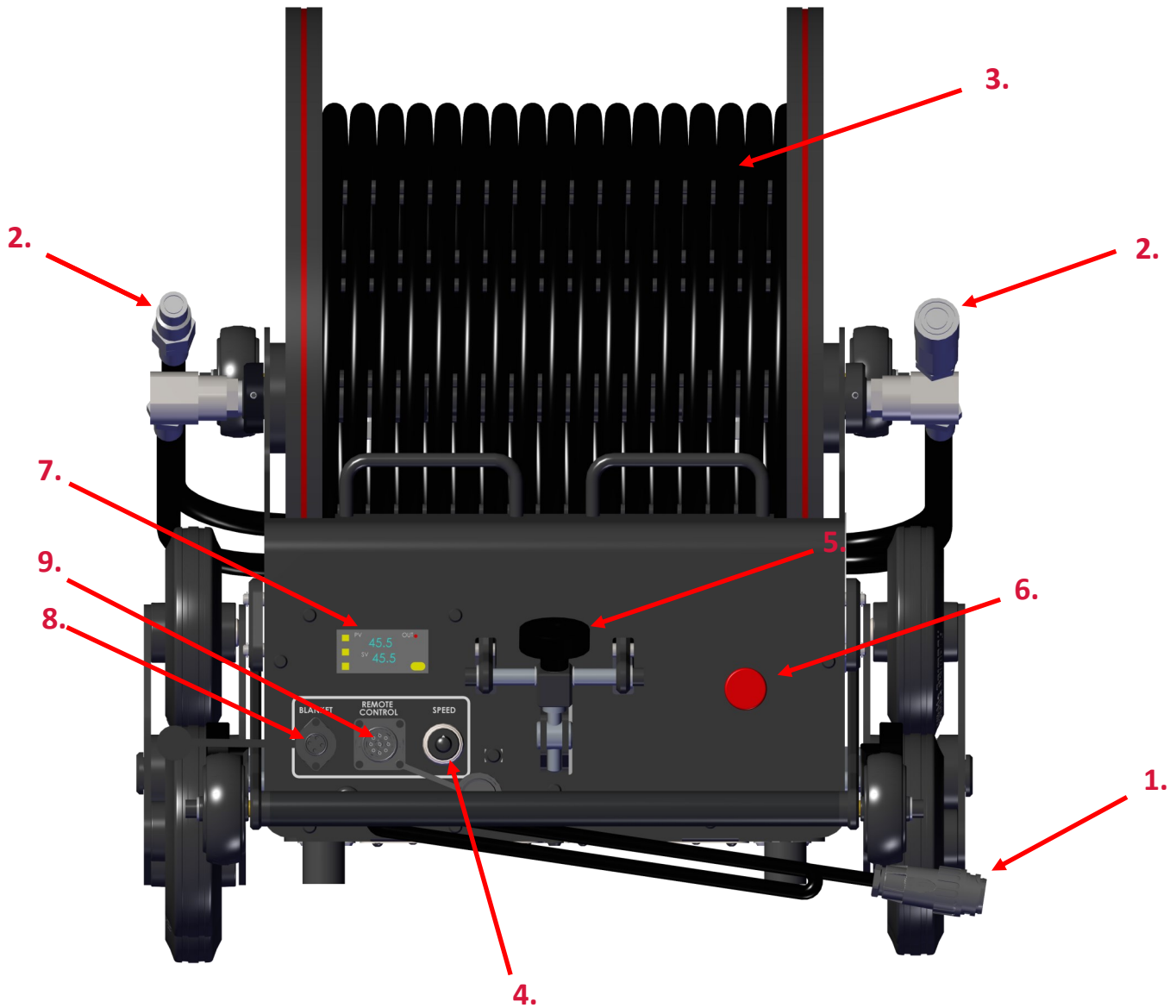

## General Description

1. Power Cord
2. Resin Supply Hoses
3. Delivery Hoses
4. Hose Reel Speed Control
5. Hose Reel Brake Control
6. Emergency Stop
7. Heating Blanket Thermostat
8. Heating Blanket Connector
9. Remote Control Connector



## SAVE ALL WARNINGS AND INSTRUCTIONS FOR FUTURE REFERENCE

### Emergency Stop

Engaging the Emergency Stop on the Hose Reel will result in the system shutting down. The pump actuators will stop and the retraction of the Hose is prevented.



**NOTE! The Xpress Pump Cylinder Heaters & Hose Reel Heating Blanket/ Heating Blanket Power Connection Outlet will still have power.**



### Hose Retraction Clutch

On the Hose Reel there is a knob which can be used to adjust the level of clutch engagement. Turn the knob clockwise to tighten the clutch and counter clockwise to loosen it.

The clutch needs to be released in order to pull the delivery hoses from the Reel.

When the correct length of delivery hose has been pulled off, re-tighten the clutch in order to use the automated hose return while coating. Alternatively you can manually wind the hose reel to take up the delivery hose if desired.

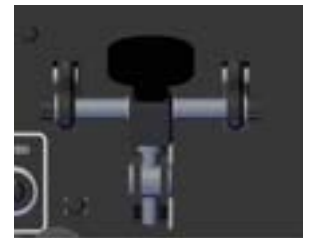

### Hose Retraction Speed Knob



The hose retraction speed can be adjusted with the knob on the Hose Reel.



### Hose Reel Pull Handle

The Pull Handle on the Hose Reel can be extended and retracted by loosening the knobs on the sides.

There are several positions where the pull handle can be locked in place.

When in use retract the pull handle all the way so that the Hose Reel rests on the rubber feet to help prevent the Hose Reel from accidentally moving around.



# XPRESS COATING SYSTEM | HOSE REEL HEATING BLANKET

SAVE ALL WARNINGS AND INSTRUCTIONS FOR FUTURE REFERENCE

## The Heating Blanket

The Picote Coating System includes a Heating Blanket which is used to heat up the Hose Reel delivery hoses and the resin inside.

To put on the Heating Blanket, attach it to the Hose Reel with the Velcro strips.

Rotate the Hose Reel so it pulls the Blanket around it.

Push the temperature sensor through the hoses to the inside of the Reel to allow for a more accurate temperature reading.

Close and secure the Heating Blanket with the Velcro fasteners.

Plug Heating Blanket into the Hose Reel connector marked "Blanket".

Once the system is powered up, the Heating Blanket will also turn ON.



# XPRESS COATING SYSTEM | REMOTE CONTROL

SAVE ALL WARNINGS AND INSTRUCTIONS FOR FUTURE REFERENCE

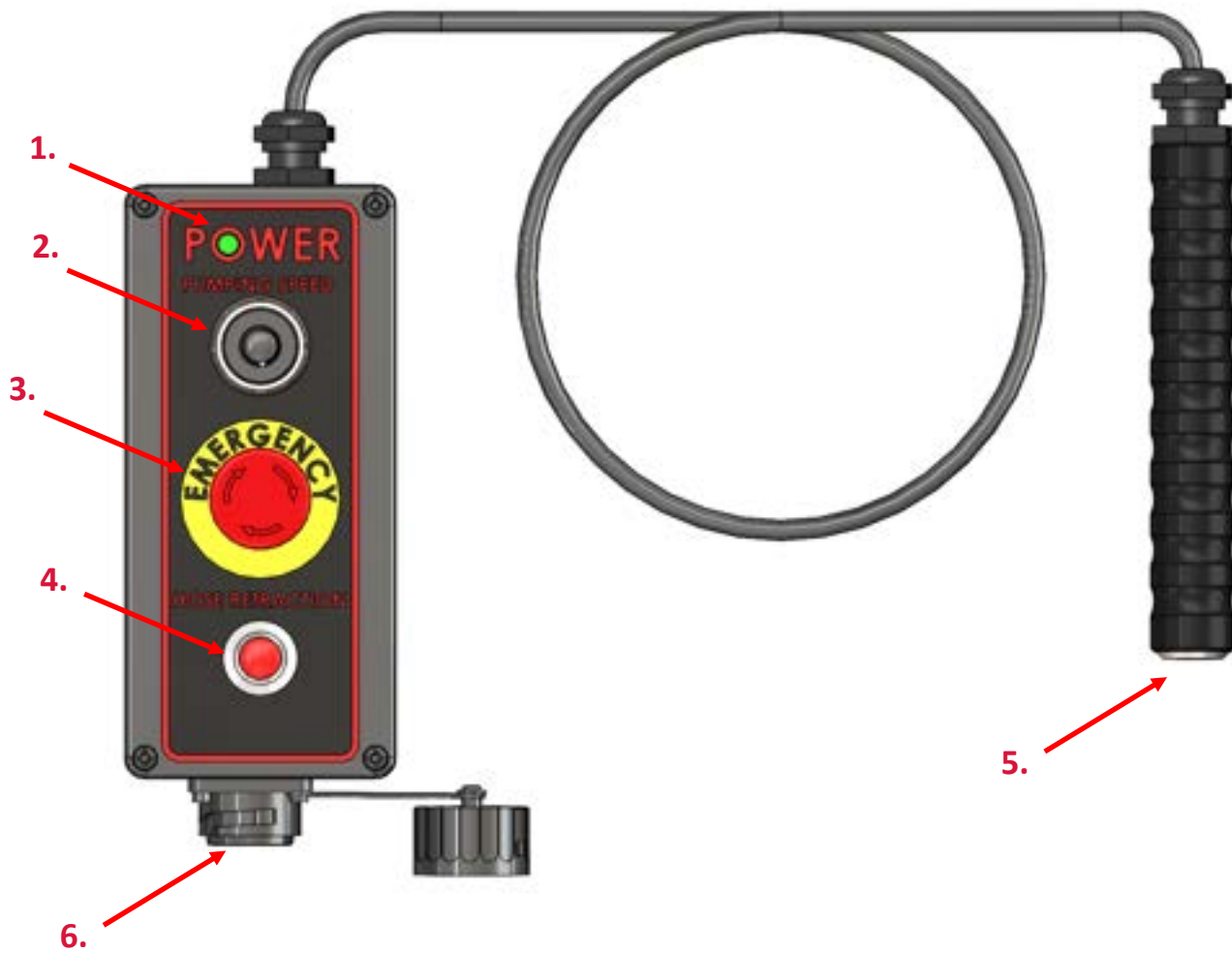

## General Description

1. Power Light
2. Pumping Speed Knob
3. Emergency Stop
4. Hose Retraction Button
5. Stop / Start Button for Pump
6. Remote Control Cable Connector

# XPRESS COATING SYSTEM | REMOTE CONTROL

SAVE ALL WARNINGS AND INSTRUCTIONS FOR FUTURE REFERENCE

## The Emergency Stop

Engaging the Emergency Stop on the Remote Control will result in the system shutting down. The pump actuators will stop and the retraction of the Hose is prevented.



**NOTE: The Xpress Pump Cylinder Heaters & Hose Reel Heating Blanket/ Heating Blanket Power Connection Outlet will still have power.**



## Pumping Speed

The pumping speed can be adjusted by turning the knob on the remote control from 0 to 10 with 0-2 being the slowest setting. Slowest speed is recommended when coating. Faster speeds can be used for filling mode.



## Start Button

The Start Button is a locking button. When pressed, the actuators will move pistons up or down depending on the Direction Switch setting.



## The Hose Retraction



On the Remote Control there is a button that can be used to retract the delivery hoses back to the Hose Reel. This way the operator can rewind the excess hose back to the Reel without stopping the coating process.

**NOTE: Retraction speed and clutch strength can be adjusted at the Hose Reel.**



# XPRESS COATING SYSTEM | INITIAL SETUP

SAVE ALL WARNINGS AND INSTRUCTIONS FOR FUTURE REFERENCE

## **⚠ WARNING**

This section contains important safety information.  
Failure to comply could result in serious injury or death.

### Charging the Battery

The Xpress Coating System is delivered battery detached. The battery must be connected before use. It can be found behind the battery access panel. To connect it, first make sure the machine is turned OFF. Take out three screws and move the panel aside. Connect the battery and tuck the wires on top of the battery.

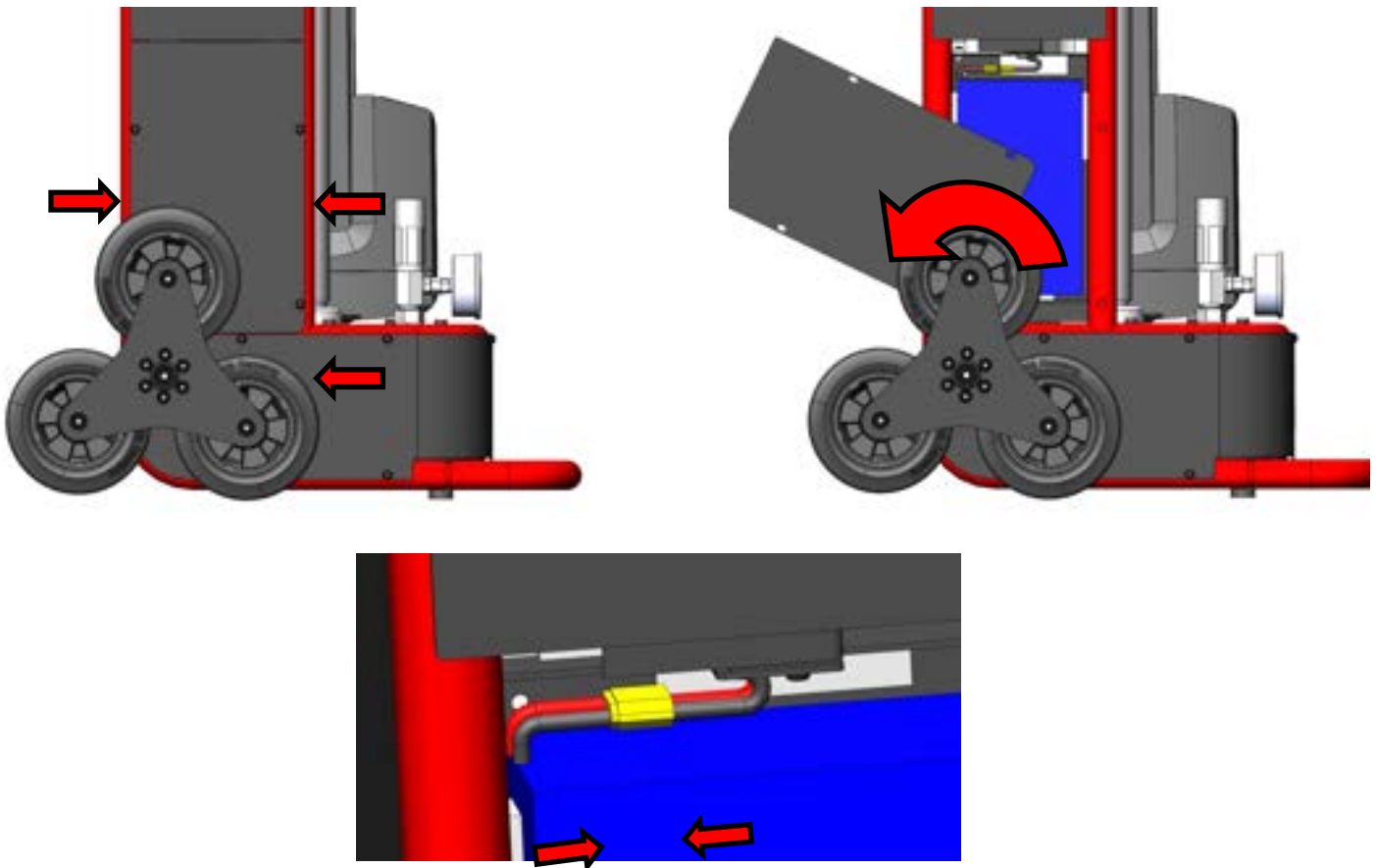

- Before using the Xpress Coating System, charge the battery to 100%.
- To charge the battery, attach the power cord to the Xpress Coating Pump.
- **Make sure the Power Switch is set to the OFF position.**
- Charging will start automatically.
- To check the battery level, turn the main power switch to the ON position.
- **NOTE:** When in use, Cylinder Heater will cause battery level indicator to appear lower than actual. To check the true level, temporarily turn OFF Cylinder Heater thermostat & disconnect Reel Heating Blanket (if connected).

# XPRESS COATING SYSTEM | INITIAL SETUP

**SAVE ALL WARNINGS AND INSTRUCTIONS FOR FUTURE REFERENCE**

## Preparing the Hose Reel

Before using the Hose Reel the delivery hoses need to be position correct by pushing them through the hose guides.



## Initial Filling and Bleeding of the System

**NOTE: The Xpress Coating System has been pressure tested with medical grade lubricant. Residual oil inside the system will come out during system bleeding.**

1. Ensure Resin in the Resin Buckets (Base & Catalyst) are at room temperature.
2. Connect both Resin Supply Hoses and the electrical power cord to the Xpress Pump.
3. Connect Remote Control to the Hose Reel.
4. Turn ON the Xpress Pump.
5. Confirm Cylinder heat reaches 40 to 50°C (104-122°F). **Note:** temperature comes pre-set at the factory.
6. Position the Hose Reel close to the Pump and release the Reel brake.
7. Unwind enough of the Reel Delivery Hoses so that they can be positioned into a waste bucket.
8. Wrap Reel Heating Blanket around Hose Reel/Delivery Hoses & connect power (see page 17).
9. Confirm Hose Reel heat reaches 35 to 50C° (95-122°F). **Note:** temperature comes pre-set at the factory.
10. Remove the plugs from reservoir lid quick connectors. They can be stored in the storage holes on the lids.
11. Allow the Cylinder Heater and Hose Reel heat up and stay on for at least 60 minutes.
12. Position delivery hoses into an empty bucket. The excess lubricant and first small amount of pumped resin should be discarded according to local regulations.
13. Set the Direction Switch to Coating.
14. Drive the Pistons all the way down.
15. Open the Reservoir Lids.
16. Ensure that the Valves are closed.
17. Fill up the Base and Catalyst Reservoirs with the correct resin components and close the lids.  
**Be sure to pour the correct component into the correct resin reservoir! Base = White, Catalyst = Black**
19. Change direction switch to Filling mode to draw resin into cylinders.
20. Drive the pistons all the way up.
21. When the Pump stops, change direction switch to Coating mode.
22. Close the BASE valve. Start to pump the pistons down and close the CATALYST valve when the BASE pressure starts to rise on the gauge.
23. Drive the pistons are all the way down.
24. REPEAT Steps 14 through 22 approximately 3 times, or until any remaining system pressure testing lubricant has been expelled and coating resin starts flowing from the delivery hoses. One component might start flowing before the other, this is normal.
25. When both resin components are flowing, stop pumping and then attach the delivery hoses to the Reservoir Lid quick connectors.
26. **The Xpress System is now ready for use.**

# PICOTE MILLERS | 8MM (1/3") SHAFT

SAVE ALL WARNINGS AND INSTRUCTIONS FOR FUTURE REFERENCE

## WARNING

This section contains important safety information. Failure to comply could result in serious injury or death. Refer to Miller Operation Manuals

Note: The Xpress Coating System can be used with the Mini Cleaner, Battery Mini Cleaner, Mini Cleaner +C, Battery Mini Cleaner +C, Mini Miller +C, Battery Mini Miller and Battery Mini Miller +C. If using one of those Millers please read and follow that Millers' Safety and Operation Manual.

### Picote Mini Miller



## General Description

1. Shaft Reel
2. Frame
3. Flexible Shaft
4. Motor & Bevel Gear (not shown)
5. Emergency Stop Bottom (red)
6. Power Switch
7. Speed Control
8. Foot Pedal—Operator Presence Control
9. Hand Guard & Strain Relief/inside Hand Guard (not seen in photo)

## Intended Use

This machine is intended for the following uses:

- Mini Miller: Coating pipes DN50-150 (2-6")
- Mini Cleaner: Coating Pipes DN32-100 (1¼-4")
- Cleaning and unblocking pipes, drains and sewers.
- Descaling pipes.
- Reinstating branches in pipes by drilling & grinding.
- Cutting excess length of cured CIPP linings.

**Always follow manufacturer's instructions when installing and using the machine with accessories.**

# PICOTE MILLERS | 8MM (1/3") SHAFT

SAVE ALL WARNINGS AND INSTRUCTIONS FOR FUTURE REFERENCE

## WARNING

This section contains important safety information. Failure to comply could result in serious injury or death. Refer to Miller Operation Manuals

Note: The Xpress Coating System can be used with the Mini Cleaner, Battery Mini Cleaner, Mini Cleaner +C, Battery Mini Cleaner +C, Mini Miller +C, Battery Mini Miller and Battery Mini Miller +C. If using one of those Millers please read and follow that Millers' Safety and Operation Manual.

### MINI MILLER 8/16

SIZE	SHAFT	RANGE	ROTATING SPEED	OUTPUT (kW)	POWER SOURCE	WEIGHT
752x519x389	8mm	16m	500-2900rpm	110V:1.1kW	110v or 230v	27kg
29.6x20x15.3"	1/3"	50ft	500-2900rpm	230V:1.2kW	110v or 230v	59.5lb

### MINI CLEANER 8/16

SIZE	SHAFT	RANGE	ROTATING SPEED	OUTPUT (kW)	POWER SOURCE	WEIGHT
1122x712x466	8mm	16m	500-1500rpm	110V:1.5kW	110v or 230v	26.5kg
44x28x18"	1/3"	50ft	500-1500rpm	230V:1.5kW	110v or 230v	152lb

When in use, always lay the machine down horizontally on the floor as shown above.

When not in use, some non-hazardous Picote Flexible Shaft Lubricant might leak from the hand guard.



#### VOLTAGE

Ensure that the supply voltage is correct. The voltage of the power source must match the value given on the nameplate of the machine.



#### POWER SUPPLY

The machine should be connected only to a power supply of the same voltage as indicated on the nameplate, and can only be operated on single-phase AC supply.



#### FOOT PEDAL

The machine has an Operator Presence Foot Control or 'OPC'. When the control is not held down, the machine stops.



#### EMERGENCY STOP

There is an Emergency Stop Button (E-stop) on the machine. The power supply to the motor is cut off when the E-stop button is pushed. Always make sure the E-Stop Button is pressed and then completely unplug the machine when accessories (e.g. Cleaning Chains) are not inside the pipe.



#### Xpress Coating System has been pre-set by the Manufacturer

Picote Solutions accepts no liability for failures or accidents caused by tampering with or changing of the manufacturer settings. The control box has been pre-programmed and requires no additional adjustments.



**Opening the control box or changing the factory settings may cause damage and will void the manufacturer liability of any damage!**



# PICOTE MILLERS | 10 & 12 MM (3/8 & 1/2") SHAFT

SAVE ALL WARNINGS AND INSTRUCTIONS FOR FUTURE REFERENCE

## **WARNING**

This section contains important safety information. Failure to comply could result in serious injury or death. Refer to Miller Operation Manuals

Note: The Xpress Coating System can be used with the Mini Cleaner, Battery Mini Cleaner, Mini Cleaner +C, Battery Mini Cleaner +C, Mini Miller +C, Battery Mini Miller and Battery Mini Miller +C. If using one of those Millers please read and follow that Millers' Safety and Operation Manual.

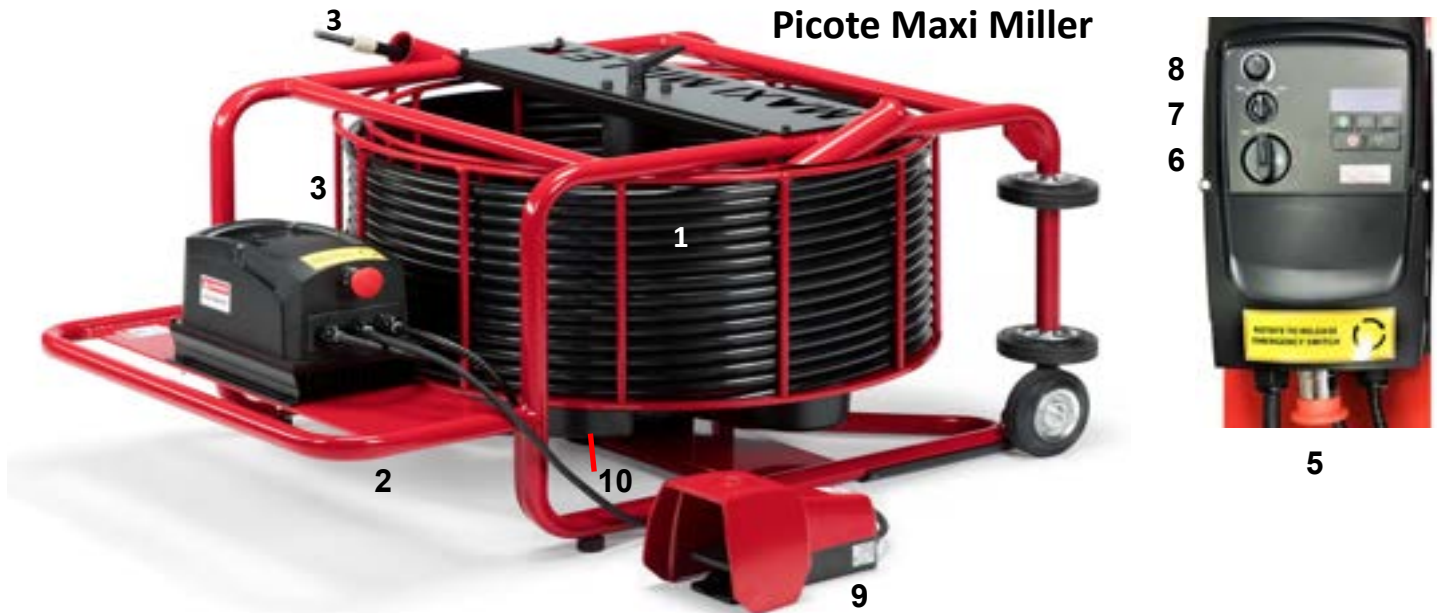

## General Description

1. Shaft Reel
2. Frame
3. Flexible Shaft
4. Motor & Bevel Gear (not shown)
5. Emergency Stop Bottom (red)
6. Power Switch
7. Forward/Reverse
8. Speed Control
9. Foot Pedal—Operator Presence Control
10. Hand Guard & Strain Relief / Inside Hand Guard (hidden in picture - not shown)

## Intended Use

This machine is intended for the following uses:

- Midi Cleaner: Coating Pipes from DN50-200 (2-8")
- Super Midi: Coating Pipes from DN70-200 (3-8")
- Maxi Miller: Coating pipes from DN70-300 (3-12")
- Cleaning and unblocking pipes, drains and sewers.
- Descaling pipes.
- Reinstating branches in sewers and drains by drilling and grinding.
- Cutting excess length of cured linings.
- Removing concrete deposits.
- Removing metallic inserts.

**Always follow the manufacture's instructions when installing and using the machine with accessories.**

# PICOTE MILLERS | 10 & 12 MM (3/8 & 1/2") SHAFT

SAVE ALL WARNINGS AND INSTRUCTIONS FOR FUTURE REFERENCE

## ⚠️ WARNING

This section contains important safety information. Failure to comply could result in serious injury or death. Refer to Miller Operation Manuals

### MAXI MILLER 12/30

SIZE	SHAFT	RANGE	ROTATING SPEED	OUTPUT (kW)	POWER SOURCE	WEIGHT	IP CLASS
1150x850x489	12mm	30m	500-1500rpm	110V:1.13kW	110v or 230v	89kg	54
45x34x19"	1/2"	100ft		230V:1.5kW		196lb	

### SUPER MIDI MILLER 12/20

SIZE	SHAFT	RANGE	ROTATING SPEED	OUTPUT (kW)	POWER SOURCE	WEIGHT	IP CLASS
1122x712x466	12mm	20m	500-1500rpm	110V:1.5kW	110v or 230v	69kg	54
44x28x18"	1/2"	65ft		230V:1.5kW		152lb	

### MIDI CLEANER 10/23

SIZE	SHAFT	RANGE	ROTATING SPEED	OUTPUT (kW)	POWER SOURCE	WEIGHT	IP CLASS
1122x712x466	10mm	23m	500-1500rpm	110V:1.5kW	110v or 230v	65kg	54
44x28x18"	3/8"	75ft		230V:1.5kW		152lb	

When in use, always lay the machine down horizontally on the floor as shown above.  
When not in use, some non-hazardous Picote Flexible Shaft Lubricant might leak from the hand guard.

#### VOLTAGE



Ensure that the supply voltage is correct. The voltage of the power source must match the value given on the nameplate of the machine.

#### POWER SUPPLY



The machine should be connected only to a power supply of the same voltage as indicated on the nameplate, and can only be operated on single-phase AC supply.

#### FOOT PEDAL



The machine has an Operator Presence Control or 'OPC'. When the control is not held down, the machine stops.

#### EMERGENCY STOP



There is an Emergency Stop Button on the machine. The power supply to the motor is cut off when the Emergency Stop Button is pushed. Always make sure the Emergency stop Button is pressed & completely unplug the machine when machine accessories (e.g. Cutter or Grinding Chains) are not inside the pipe.

#### Xpress Coating System has been pre-set by the Manufacturer

Picote Solutions accepts no liability for failures or accidents caused by tampering with or changing of the manufacturer settings. The control box has been pre-programmed and requires no additional adjustments.

**Opening the control box or changing the factory settings may cause damage and will void the manufacturer liability of any damage!**



# XPRESS COATING SYSTEM | PIPE PREPARATION

## SAVE ALL WARNINGS AND INSTRUCTIONS FOR FUTURE REFERENCE

Substrate preparation is one of the most crucial steps in the coating process as specialized coating resin is designed to bond to the host pipe. Be sure to remove all scale, grease, dust, standing water and any other debris completely from the pipe before coating. If coating plastic pipe be sure to thoroughly abrade with Picote Smart Cutter™ side grinding panels.

### ⚠ WARNING

This section contains important safety information.  
Failure to comply could result in serious injury or death.



**STEP 1** ▶ Clean host pipe very well. Use Original (a) or Cyclone (b) chains with carbides for cast iron pipes, followed by Picote Smart Cutter™ grinding panel, then flushed with water and dried. For PVC pipes, use PVC versions of these chains (c) and/or thoroughly abrade with Picote Smart Cutter™ grinding panels (e) followed by a wire brush (d) to remove dust & other remaining particles. Afterwards the pipe should be flushed and dried.



**OPTIONAL STEP:** For pipe with excessive build-up of fats, oils or grease (FOG) a degreaser may be necessary. This can be pumped into the pipe during cleaning if necessary using the coating pump system and eco-friendly degreasing agent.

**STEP 2** ▶ When necessary, run the Smart Cutter™ with side grinding panels through the pipe to create a rough surface and to allow for the resin to have the best possible bond to the pipe wall.

**STEP 3** ▶ The pipe MUST not have any standing liquid or active INI before continuing with the coating setup. You can use various methods to remove liquid from the pipe include rags, pipe pigs, or the Picote Heater to expedite the process.

The pipe can be 'damp' but cannot have any liquids that would mix with the resin when coating.



Once the original pipe is completely clean, move on to the Coating System Preparation



# COATING SYSTEM ASSEMBLY | BRUSHES

SAVE ALL WARNINGS AND INSTRUCTIONS FOR FUTURE REFERENCE

## Before Beginning Assembly

### Required Tools & Parts

- Picote Coating Brushes (1 or 2)
- Picote Brush Stopper
- Picote Sleeve
- 2.5mm Hex Key
- Adjustable Wrench



## ⚠ WARNING

This section contains important safety information.  
Failure to comply could result in serious injury or death.



### Personal Protective Equipment (PPE)

- Always use Personal Protective Equipment including suitable protective clothing, footwear, suitable eye protection to protect against injuries and chemicals from irritating eyes, suitable heat and cut-resistant gloves to help prevent any hand injuries.
- **Danger: Risk of serious injury from rotating parts!**
- Have extra brush stoppers and hose connectors available.
- Use an angle grinder or portable band saw to cut Miller shaft if necessary.
- Have a roll of PVC tape available.



# COATING SYSTEM ASSEMBLY | BRUSHES

## SAVE ALL WARNINGS AND INSTRUCTIONS FOR FUTURE REFERENCE

### STEP 1

Select the appropriate brush size for the pipe.

**Always use a brush one pipe size larger than the pipe to be coated.**

*Note: Although one brush can be used in straight pipe, dual brushes are required for pipes with bends or transitions (except in DN32 (1¼") pipes where only 1 brush is used at all times).*

Recommended Coating Brush Diameters for: 8mm (1/8") Shaft Millers (Mini Cleaner / Mini Miller)				
10mm (3/8") Shaft Millers (Midi Cleaner)				
Host Pipe Diameter	Front Coating Brush Diameter (Straight)	Front Coating Brush Diameter (Multiple Bends)	Rear Coating Brush	Distance Between Brushes
DN32 (1¼")	50mm (2")	N/A	N/A	N/A
DN40 (1½")	50mm (2")	50mm (2")	50mm (2")	20mm (1½")
DN50 (2")	75mm (3")	100mm (4")	50mm (2")	50mm (2")
DN70 (3")	100mm (4")	125mm (5")	75mm (3")	75mm (3")
DN100 (4")	125mm (5")	175mm (7")	100mm (4")	100mm (4")
DN150 (6")	175mm (7")	220mm (9")	150mm (6")	150mm (6")

**\*\* If coating pipe diameters ≤ DN50 (2") use the Xpress Small Pipe Coating Kit**

Recommended Coating Brush Diameters for 12mm (1/2") Shaft Millers (Super Midi / Maxi Miller)				
Host Pipe Diameter	Front Coating Brush Diameter (Straight)	Front Coating Brush Diameter (Multiple Bends)	Rear Coating Brush	Distance Between Brushes
DN70 (3")	100mm (4")	125mm (5")	75mm (3")	25-50mm (1-2")
DN100 (4")	150mm (6")	175mm (7")	150mm (6")	25-50mm (1-2")
DN125 (5")	175mm (7")	200mm (8")	175mm (7")	25-50mm (1-2")
DN150 (6")	200mm (8")	225mm (9")	200mm (8")	25-50mm (1-2")
DN175 (7")	225mm (9")	250mm (10")	225mm (9")	25-50mm (1-2")
DN200 (8")	250mm (10")	275mm (11")	250mm (10")	25-50mm (1-2")
DN225 (9")	275mm (11")	300mm (12")	275mm (11")	25-50mm (1-2")
DN250 (10")	300mm (12")	350mm (14")	300mm (12")	25-50mm (1-2")
DN300 (12")	350mm (14")	350mm (14")	350mm (14")	25-50mm (1-2")

# COATING SYSTEM ASSEMBLY | BRUSHES

SAVE ALL WARNINGS AND INSTRUCTIONS FOR FUTURE REFERENCE

- STEP 2** ▶ Always use a sleeve on the outer casing of the Miller shaft. Attach the smaller brush against the sleeve leaving roughly 6mm (1/4") between the Brush hub and Sleeve and securely tighten the two 2.5mm set screws.

**NOTE: Do not over tighten or screws my strip the Brush Hub.**

**TIP: Always mount the brushes onto a Leader. This will make cleanup easier and extend the life of your Miller Shaft by reducing the number of times you will need to cut back the outer casing or excess shaft.**

*The larger of the 2 brushes will be the brush at the tip of the shaft and is used for finishing the resin. Closest brush helps to spread the resin and stabilize the brush set during coating.*

- STEP 3** ▶ Slide the larger Coating Brush onto the shaft followed by a Brush Stopper. Bring to the end and tighten both securely.

- STEP 4** ▶ Refer to the table on page 28 for the distance between the front and rear brushes and leave space between the brushes with no need for casing over the shaft. This will allow for flexibility around bends.

**ONCE BRUSHES ARE SET UP, MOVE ON TO DELIVERY HOSE AND CAMERA PREPERATION.**



# COATING SYSTEM ASSEMBLY | DELIVERY HOSE & CAMERA

SAVE ALL WARNINGS AND INSTRUCTIONS FOR FUTURE REFERENCE

## Required Tools & Parts:

- Static Mixing Tip
- Y-Connector
- Electrical Tape
- Camera
- Scissors



- STEP 1** ▶ Attach the delivery hose mixing tip and Y-connector 50mm (2") behind the Sleeve with Electrical tape.  
Exactly 300mm (12") away, apply a second piece of tape securing the delivery hose to the Miller Shaft.



- STEP 2** ▶ Tape the camera head behind the Sleeve.  
Inspect the camera CCTV screen to ensure you have a good and full view of the Coating Brushes.



- STEP 3** ▶ Once the brush is in full view on the screen, tape the camera head from the very end all the way to the end of the camera spring.  
This will ensure the camera spring and connectors inside stay clean during the process.



- STEP 4** ▶ Once the camera is secure, insert the brushes in to the pipe opening.  
Push in about 500mm (18") and tape camera, Delivery Hose and Miller Shaft together.



# XPRESS COATING SYSTEM | RESIN PREPERATION

SAVE ALL WARNINGS AND INSTRUCTIONS FOR FUTURE REFERENCE

## Before Beginning Preparation

### Required Tools & Parts:

- Xpress Coating System
- Picote Xpress Epoxy
- Picote Reel Heating Blanket
- Nitrile Gloves
- Paper Towels
- Acetone
- Waste Container

**TIP: Resins have limited work time.**

**Higher temperatures will decrease the work time.**

**If too cold, the resin may become difficult to pump.**

**Recommended Ambient Pipe Temperature: +20 to +30°C (65-86°F)**

**Minimum/Maximum Ambient Pipe Range: +15 to +50°C (59-122°F)**

**Recommended Resin Temperature: +25 to +30°C (77-86°F)**

## WARNING

**This section contains important safety information.  
Failure to comply could result in serious injury or death.**



### Personal Protective Equipment (PPE)



- Always use Personal Protective Equipment including suitable protective clothing, footwear, suitable eye protection to protect against injuries and chemicals from irritating eyes, suitable heat and cut-resistant gloves to help prevent any hand injuries.
- Any open injuries or skin irritations should always be covered to avoid contact with sewage, chemicals or dust.
- A suitable respirator to prevent any dust or fumes being inhaled or consumed, which could cause occupational asthma or dermatitis.
- Have plenty of disposable nitrile gloves and paper towels available. Wearing a double layer of disposable gloves is useful when working with resins to avoid contact with the skin. The top pair can be removed easily during clean up to help eliminate mess.
- In case of spills or accidents a chemical spill kit and acetone readily available.

### STEP 1

► Be sure to check that both Resin Reservoirs have been filled before pumping any resin. This will allow you to have more efficient workflow.

If the Resin has been stored in temperatures under 15°C (59°F) temperatures, or if the working ambient temperature is below 30°C (86°F) or it is advised to heat up the resin buckets using a second Hose Reel Heating Blanket, or in a heated container.

It is recommended to keep resin containers heated during the entire coating process.

**If the Resin, Hose Reel with resin inside, or Xpress Pump with resin have been stored unused longer than 1 month, or for any extended period under 15°C (59°F) temperature, please perform the resin maintenance/decrystalization process detailed on page 33 .**



# XPRESS COATING SYSTEM | RESIN PREPERATION

SAVE ALL WARNINGS AND INSTRUCTIONS FOR FUTURE REFERENCE

## Resin Calculator

Use the resin calculator to determine how much resin will be needed to complete all necessary coats. Refer to the chart below for recommended number of coats. The resin calculator can be downloaded from the Picote Institute ([picoteinstitute.com](http://picoteinstitute.com)).

Pipe Diameter	Number of Applied Coats For Internal Pipe Work (Corrosion Resistance)	Number of Applied Coats For Buried Pipework (Semi Structural)
DN32 (1¼")	1	1
DN40 (1½")	1	1
DN50 (2")	2	2
DN70 (3")	2	2
DN100 (4")	2	3 to 4
DN150 (6")	2 to 3	4 to 5
DN200 (8")	3 to 4	5 to 6
DN225 (9")	4 to 5	6 to 7
DN250 (10")	4 to 5	7 to 8
DN300 (12")	5 to 6	8 to 9

### Addition Requirements for Special Applications:

- A minimum of 4 coats need to be applied when the pipe is going to be cleaned using High Pressure Water Jetting.
- Maximum Water Jetting Pressure = 2600 PSI (180 Bar).
- Minimum of 3 coats is needed for abrasion resistance.

**STEP 2** ► Fill up the pump reservoirs with corresponding resin components. Use a smaller pitcher to pour the resin.



**Be extremely careful not to mix up the Base (White) and Catalyst (Black) Resins vs their corresponding Resin Reservoirs.**

**Failure to do this can cause permanent damage to the system!**



## SAVE ALL WARNINGS AND INSTRUCTIONS FOR FUTURE REFERENCE

### Maintenance: Recycling the Resin / Decrystallizing Process

If the system has been stored unused for more than 1 month, or has been stored in cold temperatures then we recommend recirculating the resin through the heated Reel and Pump before future coating jobs. This allows the resin to decrystallize and also helps to ensure the resin viscosity is consistent.

1. Connect both Resin Supply Hoses and the electrical power cord to the Xpress Pump.
2. Connect Remote Control to the Hose Reel.
3. Turn ON the Xpress Pump.
4. Confirm Cylinder Heater is set to 50°C (122°F). Note: temperature comes pre-set at the factory.
5. Position the Hose Reel close to the Pump and release the Reel Brake.
6. Unwind enough of the Reel Delivery Hoses so that they can reach the top of the Resin Reservoirs located on the Xpress Pump and then remove another 1m (3') off the Hose Reel.
7. Wrap Reel Heating Blanket around Hose Reel/Delivery Hoses & connect power (see page 17).
8. Confirm Hose Reel Heat is set to 35°C (95°F). Note: temperature comes pre-set at the factory.
9. Allow the Cylinders and Hose Reel to heat up for at least 60 minutes.
10. Remove the plugs from reservoir lid quick connectors. They can be stored in the holes on the lids.
11. Connect the Hose Reel Delivery Hoses into the corresponding Base (White) and Catalyst (Black) Resin Reservoir Connections on the top of each Reservoir.  
**Be sure to attach the correct hose to the corresponding Base or Catalyst Resin Reservoir to avoid adding the wrong Resin component into the wrong reservoir. Not ensuring this could cause serious damage to the Xpress Coating System.**
11. Set the Direction Switch to Coating mode.
12. Drive the pistons all the way down.
13. Change the Direction Switch to Filling mode to draw resin into cylinders.
14. Drive the pistons all the way up.
15. When the Pump stops, change direction switch to Coating mode.
16. Close the BASE valve.
17. Start to pump the pistons down, close CATALYST valve as soon as BASE pressure on gauge starts to rise.
18. Drive the pistons are all the way down.
19. Repeat this process 3 times to completely recirculate and thoroughly heat the resin.
20. Remove the Hose Reel Delivery Hoses from the connections on the Resin Reservoirs, wipe clean & cap.



## SAVE ALL WARNINGS AND INSTRUCTIONS FOR FUTURE REFERENCE

### Before Beginning Assembly

#### Required Tools & Parts

- XPRESS Coating System
- Scissors
- Tubing Cutters
- Towels
- Gloves
- Chemical Spill Kit
- Acetone

## WARNING

This section contains important safety information.  
Failure to comply could result in serious injury or death.



### Personal Protective Equipment (PPE)



- Always use Personal Protective Equipment including suitable protective clothing, footwear, suitable eye protection to protect against injuries and chemicals from irritating eyes, suitable heat and cut-resistant gloves to help prevent any hand injuries.



- Any open injuries or skin irritations should always be covered to avoid contact with sewage, chemicals or dust.

- A suitable respirator to prevent any dust or fumes being inhaled or consumed, which could cause occupational asthma or dermatitis.



- Have plenty of disposable nitrile gloves and towels available. Wearing a double layer of disposable gloves is useful when applying lubricant and working with resins.

- **DANGER, Risk of serious injury from moving parts!**

- Be sure that all machines have the required power supply.
- Test machines and power source to ensure adequate and safe operation.
- Read Machine Operation and Safety Manual.

# XPRESS COATING SYSTEM | COATING SYSTEM PREPERATION

SAVE ALL WARNINGS AND INSTRUCTIONS FOR FUTURE REFERENCE

## ⚠ WARNING

Before coating with the XPRESS Coating System, the system needs to be bled of any air and filled with resin.

- STEP 1** ▶ Connect the Hose Reel resin supply hoses to the Pump.  
**Open Reservoir Valves to relief pressure buildup inside the cylinders.**  
**If hoses do not connect with reasonable force, open hose connection to relieve pressure.**
- STEP 2** ▶ Connect the Hose Reel electric cable to the Pump.
- STEP 3** ▶ Connect the remote electric cable to the Hose Reel and to the Remote Control.
- STEP 4** ▶ Turn ON the Pump.
- STEP 5** ▶ Put the Reel Heating Blanket on the Hose Reel and connect it to preheat the resin in the hoses. The hoses should be warmed up for at least 30min. If the ambient temperature is below 20°C (68°F), 60 minutes of warming is recommended. The Reel Blanket Heater thermostat is preset to 35C° (95°F).
- STEP 6** ▶ Press the Emergency Check button. If the light on the button does not go off, check all of the emergency stop switches and also that the Safety Screen is fully closed.
- STEP 7** ▶ Press the Check Button.
- STEP 8** ▶ Remove all the plugs from the Reservoir Lid quick connectors. Store the plugs in the blank holes on the lids.
- STEP 9** ▶ Fill the Resin Reservoirs with Base & Catalyst Resin and put the lids back on.  
**NOTE! Resin Reservoirs should be only be filled when pistons are in the fully down position.**
- STEP 10** ▶ Open the Reservoir Valves.
- STEP 11** ▶ If needed, fill the cylinders by selecting FILLING mode on the direction switch and pressing the Start Button on the remote.  
**NOTE! You can use faster pumping speeds when filling the Resin Cylinders than during actual coating processes.**  
**Once the cylinders have been filled, heat the resin via the cylinder heaters and allow to warm up for 30-60 minutes depending on the ambient temperature.**



## SAVE ALL WARNINGS AND INSTRUCTIONS FOR FUTURE REFERENCE

### Before Beginning Coating

#### Required Tools & Parts:

- Xpress Coating System
- Picote Miller
- Picote Xpress Resin
- Nitrile Gloves
- Scissors
- Paper Towels
- Acetone
- Waste Container
- Chemical Spill Kit

## WARNING

This section contains important safety information.  
Failure to comply could result in serious injury or death.



### Personal Protective Equipment (PPE)

- Always use Personal Protective Equipment including suitable protective clothing, footwear, plus suitable eye protection to protect against injuries and chemicals from irritating eyes, suitable heat and cut-resistant gloves to help prevent any hand injuries.
- Any open injuries or skin irritations should always be covered to avoid contact with sewage, chemicals or dust.
- A suitable respirator should be used to prevent any dust or fumes being inhaled or consumed, which could cause occupational asthma or dermatitis.
- Have plenty of gloves, towels, rags, acetone and a spill kit available in case of spills or accidents.
- Use a digital infrared thermometer non-contact tool to monitor the temperature of the resin while coating.
- Make sure you have a work crew large enough to handle the coating application!



# XPRESS COATING SYSTEM | COATING WITH THE SYSTEM

## SAVE ALL WARNINGS AND INSTRUCTIONS FOR FUTURE REFERENCE

- STEP 1** ▶ Select COATING mode from the Direction Switch.
- STEP 2** ▶ Select slowest pumping speed from the remote. When coating, the slowest speed is recommended.
- STEP 3** ▶ Take off the plugs from the delivery hoses and put the delivery hose tips in to a waste resin container. Store the plugs on the reservoir lid blank holes.
- STEP 4** ▶ Close BASE Reservoir Valve
- STEP 5** ▶ To start pumping, press the Start button on the remote.
- STEP 6** ▶ Watch the pressure gauges. When the pressure starts to rise in the BASE cylinder, close the catalyst reservoir valve and continue pumping. The pressure difference shouldn't be more than 15 Bar (217 PSI).
- NOTE!** During coating, the pump stops and then resumes pumping automatically. This is normal.
- STEP 7** ▶ Pump until you see resin come out of both hoses.
- STEP 8** ▶ This step is recommended for cold ambient temperatures (below 20°C / 68°F).  
Connect the delivery hoses to the reservoir lid quick connectors. Circulate the resin completely through the system to ensure the material is flowing properly. Circulate the resin 3 full strokes/cycles.
- STEP 9** ▶ Connect the Delivery Hoses to a clean Y-connector and a Mixing Tip.
- STEP 10** ▶ Remove the Heating Blanket from the Hose Reel. If the ambient temperature is below 25°C (77°F), put the blanket back on between coats to keep the hoses and resin warm.
- STEP 11** ▶ Watch the CCTV screen for the resin flow. Note: it may be difficult to see the flow of resin if camera is turned upside-down.  
Watch closely and move the camera and Miller shaft back and forth if necessary to check for resin flow.



# XPRESS COATING SYSTEM | COATING WITH THE SYSTEM

## SAVE ALL WARNINGS AND INSTRUCTIONS FOR FUTURE REFERENCE

**STEP 12** ▶ Start coating from the far end. Pump out resin and brush it on in 1m (3ft sections). Pull slowly and evenly.

Pay close attention to resin flow and lay a consistent bead of resin into the pipe by watching the thickness of the resin bead around the brush edge.



**STEP 13** ▶ Stop Pump and brushes and push back into the pipe to visually verify coating has covered all required areas evenly.

Repeat process in 1m (3 ft) sections until pipe is fully coated.

**Brushes should always be rotating when being pulled back through the pipe for coating and stationary when being pushed into the pipe for visual inspection.**

**STEP 14** ▶ Average coat thickness is 1.0 mm (0.039”).

Carefully inspect that the resin fully covers the pipe everywhere. Be especially mindful when coating around bends and be sure to use the brush setup recommendation for coating in bends in those situations.



**STEP 15** ▶ Between coats, rinse and spin the Brushes in a bucket of acetone and clean of any excess resin before it has a chance to harden. Be sure to use a lid and rags/cover to prevent acetone from splashing out of the bucket

Remove Mixing Tip & Y-connector. Pump out a small amount of resin into a waste bucket. Note: Some Base component might come out from the Catalyst side. Cap both hoses.

**STEP 16** ▶ To speed up drying time, allow resin to gel for 10 minutes after a coat is complete apply heat using the Picote Heater to the pipe before starting the next coat.



**STEP 17** ▶ If the next coat is applied after 12 hours, the pipe will need to be abraided with Smart Cutter™ Side Grinding Panels, and any shavings/dust/debris removed from the pipe before the next coat is applied. Failing to do so will cause coating bond failure.



# XPRESS COATING SYSTEM | CLEANING THE SYSTEM

SAVE ALL WARNINGS AND INSTRUCTIONS FOR FUTURE REFERENCE

## Before Beginning the Cleaning Process:

### Required Tools & Parts:

- Nitrile Gloves
- Acetone
- Brake Cleaner
- PVC / Duct Tape
- Waste Container
- Paper Towels or Rags
- Suitable Bucket with Lid
- Chemical Spill Kit



## ⚠ WARNING

This section contains important safety information.  
Failure to comply could result in serious injury or death.



### Personal Protective Equipment (PPE)



- Always use Personal Protective Equipment including suitable protective clothing, footwear, suitable eye protection to protect against injuries and chemicals from irritating eyes, suitable heat and cut-resistant gloves to help prevent any hand injuries.
- Any open injuries or skin irritations should always be covered to avoid contact with sewage, chemicals or dust.
- A suitable respirator should be used to prevent any dust or fumes being inhaled or consumed, which could cause occupational asthma or dermatitis.
- Have plenty of gloves, towels, rags, acetone and a spill kit available in case of spills or accidents.
- Have buckets ready for cleaning the brushes and camera.
- Have a roll of PVC or duct tape and a large waste container nearby.



# XPRESS COATING SYSTEM | CLEANING SYSTEM

## SAVE ALL WARNINGS AND INSTRUCTIONS FOR FUTURE REFERENCE

### Between Coats

- STEP 1** ▶ Remove the mixing tip and pump out a small amount of resin to clear out possible backflow of mixed resin.
- STEP 2** ▶ Fill up the cylinder and reservoirs if necessary.
- STEP 3** ▶ Connect the delivery hoses to the resin reservoir lid quick connects.
- STEP 4** ▶ Circulate the resin through the system before starting a new coat.

### After Coating is Finished

- STEP 1** ▶ Try to leave the resin reservoirs as empty as possible to help avoid possible spillage during transportation. However, make sure the pump doesn't draw air into the cylinders because of having too little resin volume inside the reservoirs. You can pump the excess resin back into the individual component buckets (be sure to select the correct / corresponding bucket to avoid mixing base and catalyst).
- STEP 2** ▶ Plug the Delivery Hoses.  
For the Small Diameter Setup: Throw out the mixing tip and the small diameter delivery hose if there is one after the mixing tip. Then plug the Delivery Hoses.
- STEP 3** ▶ Remove the Resin Supply hoses from the Pump and clean both ends of the connectors with brake cleaner or acetone.
- STEP 4** ▶ Put the Reservoir Lid Plugs back to the quick connectors and check the lids are closed properly.
- STEP 5** ▶ Collect all the contained waste including used gloves, delivery hose, rags etc. into thick waste bags and seal properly. If large amounts of mixed coating resin was left, let it harden separately. Dispose according to local, regional, and national waste laws and regulation. Follow instructions from coating resin SDS.

**NOTE! Mixed resin will generate heat while curing. Do not place large amounts of mixed resin inside waste bags or buckets before it has cured and keep the excess resin in a well ventilated location while curing.**

# XPRESS COATING SYSTEM | CURING & ADDITIONAL COATS

## SAVE ALL WARNINGS AND INSTRUCTIONS FOR FUTURE REFERENCE

### CURING

During the curing process, it is very important to prevent any dirt, debris or water from getting into the pipe. The pipe must stay clean and dry during the entire coating and curing process. Water can keep the resin from bonding properly. The resin is ready for additional coats once the surface is dry to touch.

#### AMBIENT CURING:

Cure time: approximately 1.5 hrs at +21°C (70°F).

#### HEAT CURING:

Cure time: approximately 1 hr at +25°C (77°F) if Picote Heater is used.

**Note: When adding heat the coating should be allowed to gel 15 minutes after each coat before applying the Picote Heater. The pipe should never exceed a constant temperature of +65°C (150°F).**

### ADDITIONAL COATS

Refer to the chart below to determine the recommended number of coats to apply.

**If the previous coat sits longer than 12h before an additional coat is added, the pipe will need to be abraided with Smart Cutter™ Side Grinding Panels, and any shavings/dust/debris removed from the pipe.**

Pipe Diameter	Number of Applied Coats For Internal Pipe Work (Corrosion Resistance)	Number of Applied Coats For Buried Pipework (Semi Structural)
DN32 (1¼")	1	1
DN40 (1½")	1	1
DN50 (2")	2	2
DN70 (3")	2	2
DN100 (4")	2	3 to 4
DN150 (6")	2 to 3	4 to 5
DN200 (8")	3 to 4	5 to 6
DN225 (9")	4 to 5	6 to 7
DN250 (10")	4 to 5	7 to 8
DN300 (12")	5 to 6	8 to 9

#### Additional Requirements for Special Applications:

- A minimum of 4 coats need to be applied when the pipe is going to be cleaned using High Pressure Water Jetting\*.
- \*Maximum Water Jetting Pressure: 2,600 PSI (180 Bar).
- Minimum of 3 coats is needed for abrasion resistance.

### RETURN TO SERVICE

Below are the proper wait times and conditions required before returning to service:

- **4 HOURS:** Light use/restore flow, non-heated water contact
- **24 HOURS:** Pressure testing, heated water contact, fully cured

# XPRESS COATING SYSTEM | RESIN INFORMATION

**SAVE ALL WARNINGS AND INSTRUCTIONS FOR FUTURE REFERENCE**

## **100% Solids Epoxy Resin**

**Mixing ratio:** 1:1

**Pot Life:** 15 min at 25°C (68°F)

**Package Size:** 11.13 Litre (2.94 gallon) buckets.

### **Re-Coat Times:**

- Approximately: 1 hour and 30 minutes at +21°C (70°F)
- Approximately: 1 hour at +25°C (77°F)
- Can be recoated within 12 hours with no prep, **side grinding panels must be used if recoating after 12 hrs.**

**Restore Pipe Flow:** 4 hours

**Full Cure:** 24 hours

**Installation Temperature Range :** +15 to +60°C (59-140°F)

### **Finished Product Temperature Resistance:**

Up to +82°C (180°F) constant of hot water. Chemicals may change temperature resistance, please contact Picote Reseller or Picote Solutions with any questions.

**Storage Temperature:** +16 to +29°C (60-85°F)

### **Resin Life:**

- Unopened Buckets: 2 years from packaging when kept in accordance with storage instructions included in SDS and Technical Data Sheet.
- Opened Buckets: 3 months, if securely closed and kept in accordance with storage instructions included in SDS and Technical Data Sheet.
- In Hose Reel: 1 year, but resin should be reconditioned monthly (or more often depending on storage conditions)

**Industrial Safety:** Mixed product should not be allowed to come into contact with skin (it adheres).

**Gas Emissions / VOC:** No harmful VOCs (Zero VOCs) released during mixing or after hardening.

**Safety Data Sheet (SDS):** Available via QR code on resin buckets, as well as at Picote Institute (picoteinsitute.com)

**RESIN SDS AND OPERATOR CHECKLISTS ARE AVAILABLE  
TO DOWNLOAD FROM PICOTE INSTITUTE**

# XPRESS COATING SYSTEM | MAINTENANCE

## SAVE ALL WARNINGS AND INSTRUCTIONS FOR FUTURE REFERENCE

### CARING FOR THE FLEXIBLE SHAFT

See relevant Miller operating manual, available from the Picote Institute.

The flexible shaft is pre-treated with **Picote Flexible Shaft Lubricant** and the casing replaced prior to shipping. Always inspect the condition and apply oil between flexible shaft and its outer casing when required.

If necessary remove the shaft from its casing to treat. When the casing has been replaced, rotate manually for even coverage.

### CHECKING THE SCREWS

If you are unable to tighten the fastener screws properly, due to worn out hex socket heads, replace the fastener screws immediately. Otherwise, a brush or other tool can detach from the shaft during use, and fall into the pipe.

### PUMP & MILLER PARTS

Keep parts clean. Where possible, remove resin from the Coating Pump, Coating Brushes, Miller and other parts carefully with acetone or brake cleaner.

## PLEASE READ YOUR MILLER OPERATING MANUAL FOR DETAILED INSTRUCTIONS ON HOW TO PROPERLY MAINTAIN THE MACHINE

### MAINTENANCE PROGRAMME

Maintenance task	Before every use	Every month
Check for leaks	X	
Clean resin stains	X	
Check Condition of pump assembly	X	
Check lubricant level and quality	X	
Heat up the system to maximum temperature		X

### WARRANTY PERIODS

Service Period	3 months	12
A		
B		
A	Pump & spare parts, except	
B	Service Centre repair work	

## SAVE ALL WARNINGS AND INSTRUCTIONS FOR FUTURE REFERENCE

### Checking Pump Cylinder Lubricant Levels

Both Cylinders have their own Lubricant Reservoirs. Check the lubricant level by moving the Cylinders to the uppermost position. When in this position the lubricant level should be at the MAX level indicated on the Reservoirs.

If the lubricant level has gone over MAX level without adding any oil, that means the cylinder seals are leaking and need to be serviced. Contact Picote Solutions, your reseller or a Picote Authorized Service Center.

If the lubricant level has dropped, add lubricant. If the lubricant level drops quickly after use check that the cylinders are not retracted while the reservoir valves are closed. Retracting the cylinders while the reservoir valves are closed, will cause vacuum behind the cylinder piston seal which will draw the lubricant to the wrong side.

#### Adding lubricant:

1. Remove the hose from bottom of the Lubricant Reservoir
2. Guide the hoses through side panels.
3. Put the hose in to the lubricant bottle
4. Move the pistons up (FILL) and down (COAT) a couple times to flush the Cylinders.
5. Measure 25 ml (0.85 oz) of the lubricant and draw it in the Cylinders.
6. Push the hoses back inside the frame and connect them to the Lubricant Reservoirs.
7. Move the pistons up and check the lubricant level. Add or remove lubricant if necessary.



### Cleaning the Xpress Coating System

Use a clean rag and hand sanitizer or brake cleaner to wipe off resin smudges before they dry.

**Note: Do not clean the lubricant reservoirs with other than clean water and a clean cloth!**

### Resin Maintenance and Decrystallization

When the system is stored for extended periods or when exposed to cold temperatures, the resin components may start to crystallize. This can be noticed with increased pressure difference between the two cylinders. To fix this issue, follow the Resin Maintenance Instructions on page 35.

# US PARTS & ACCESSORIES

SAVE ALL WARNINGS AND INSTRUCTIONS FOR FUTURE REFERENCE



## Picote Xpress Resin

Xpress Epoxy Base and Catalyst mixes at 1:1 ratio. 100% Solids Epoxy features a superior thickness of 1mm per layer and as little as 1 hour curing time between coats at 77°F. Larger resin containers reduce waste and costs.

Product #	Resin
2220300005B	Picote Xpress Epoxy Base 2.94gal / 30.86lbs (Part A)
2220300005C	Picote Xpress Epoxy Catalyst 2.94gal / 24.15lbs (Part B)

## Xpress Coating Pump System

- For 1 ¼ - 12" Pipes
- 131 ft range

Pipe Diameter: 1 ¼-12". Max Range: 131 ft  
 The new Xpress Brush Coating System provides faster curing times, no waste, less mess, and minimal setup time for revolutionary cost and time savings, featuring dual hydraulic resin cylinders. It has a built-in 24v, 882Wh battery providing several hours of working time. The new 1:1 epoxy features an increased thickness per layer and as little as 1 hour curing time between coats at 77°F. The system also includes a motorized Delivery Hose Reel that stores 131 ft of delivery hose on board, allowing for easier setup, movement and storage. Reel Heating Blanket also included for maintaining resin temperature, and 10x flexible mixing tips.



## Picote Heater

Decrease time between coats for Picote Brush Coating™ system. Includes 16ft Heater Hose. Air outlet temperature is limited to 131F. Automatic thermal cut-out in both motor and heating element. Max. air velocity up to 100m/s and max. air volume 2.20m³/min. Minimal noise: 78dBa.



Product #	Model	MSRP
2220300000US	110v	\$51,900.00

## Reel Heating Blanket

**2220300004**

Maintains hose reel resin temperature. Runs off pump battery. (140°F max).

# US PARTS & ACCESSORIES

SAVE ALL WARNINGS AND INSTRUCTIONS FOR FUTURE REFERENCE

## Coating & Cleaning Brush



Custom designed, high-quality and long lasting brush with nylon bristles for Picote Brush Coating™ and cleaning PVC pipes. Clean with acetone and reuse.

Product #	Brush & Pipe Size	Shaft Size
2120000037	1.5" for 1.25" Pipe	1/4"
2120000050	2" for 1.25" Pipe	1/3"
2120000075	3" for 2" Pipe	1/3"
2120000100	4" for 3" Pipe	1/3"
2120000125	5" for 4" Pipe	1/3"
2120000175	6.9" for 6" Pipe	1/3"
2120000220	8.7" for 8" Pipe	1/3"
2120010075	3" for 2" Pipe	3/8"
2120010100	4" for 3" Pipe	3/8"
2120010125	5" for 4" Pipe	3/8"
2120010150	6" for 4" Pipe	3/8"
2120010175	7" for 5" Pipe	3/8"
2120010200	8" for 6" Pipe	3/8"
2120010225	9" for 7" Pipe	3/8"
2120010250	10" for 8" Pipe	3/8"
2120012100	4" for 3" Pipe	1/2"
2120012125	5" for 4" Pipe	1/2"
2120012150	6" for 4" Pipe	1/2"
2120012175	7" for 5" Pipe	1/2"
2120012200	8" for 6" Pipe	1/2"
2120012225	9" for 7" Pipe	1/2"
2120012250	10" for 8" Pipe	1/2"
2120012275	11" for 9" Pipe	1/2"
2120012300	12" for 10" Pipe	1/2"
2120012350	14" for 12" Pipe	1/2"

## Delivery Hose Lube 1 Quart

2110000003



To pre-lubricate inner surface of Coating Pump Delivery Hose to make pumping faster. If you find it difficult to push the brush/hose assembly through pipes with bends you can also apply a small amount to reduce pipe friction.

### Brush Stopper

1/3"

900000338



Provides extra security to keep the Coating Brush on the shaft. Includes one Brush Stopper.

### Brush Stopper 1/2"

900000756



Provides extra security to keep the Coating Brush on the shaft. Includes one Brush Stopper.



## Xpress Static Mixing Tip

Product #	Part
2220300001	Static Mixing Tips & Y-Fitting Package (10pcs)
2220300006	Xpress Static Mixing Tip (10 pcs)
2220300007	Xpress Y-fitting for Mixing Tip

### Other Items Needed:

Drain Camera, Resin Cups, Duct Tape, Acetone Rags & Bucket with Lid, Nitrile Gloves, Razor Knife, 3, 5, 6mm Hex Keys

SAVE ALL WARNINGS AND INSTRUCTIONS FOR FUTURE REFERENCE



## Xpress Coating Pump System

- For DN32-300 Pipes
- 40 metre range

Pipe Diameter: DN32-300. Max Range: 40m. The new Xpress Brush Coating System provides faster curing times, no waste, less mess and minimal setup time for revolutionary cost and time savings, featuring dual hydraulic resin cylinders. It has a built-in 24v, 882Wh battery providing several hours of working time. The new 1:1 epoxy features an increased thickness per layer and as little as 1 hour curing time between coats at 25°C. The system also includes a motorized Delivery Hose Reel that stores 131 ft of delivery hose on board, allowing for easier setup, movement and storage. Reel Heating Blanket also included for maintaining resin temperature and 10x flexible mixing tips.

Product #	Model
2220300000	230v
2220300000UK	110v



## Picote Xpress Resin

Xpress Epoxy Base and Catalyst mixes at 1:1 ratio. 100% Solids Epoxy features a superior thickness of 1mm per layer and as little as 1 hour curing time between coats at 25°C. Larger resin containers reduce waste and costs.

Product #	Resin
2220300003B	Picote Xpress Epoxy Base (14kg/11.13L)
2220300003C	Picote Xpress Epoxy Catalyst (11kg/11.13L)



## Picote Heater

Decrease time between coats for Picote Brush Coating™ system. Includes 5m Heater Hose. Air outlet temperature is limited to +55°C. Automatic thermal cut-out in both motor and heating element. Max. air velocity up to 100m/s and max. air volume 2.20m³/min. Minimal noise: 78dBA.

Product #	Model/Part
1350000024	Picote Heater 230v
1350000024UK	Picote Heater 110v
9990001099	Heater Hose 5 metres



## Reel Heating Blanket

**2220300004**

Maintains hose reel resin temperature. Runs off pump battery. (60°C max).



SAVE ALL WARNINGS AND INSTRUCTIONS FOR FUTURE REFERENCE

## Coating & Cleaning Brush

Custom designed, high-quality and long lasting brush with nylon bristles for Picote Brush Coating™ and cleaning PVC pipes. Clean with acetone and reuse.

Product #	Brush & Pipe Size	Shaft Size
2120000037	37mm for DN32	6mm
2120000050	50mm for DN32	8mm
2120000075	75mm for DN50	8mm
2120000100	100mm for DN75	8mm
2120000125	125mm for DN100	8mm
2120000175	175mm for DN150	8mm
2120000220	220mm for DN200	8mm
2120010075	75mm for DN50	10mm
2120010100	100mm for DN70	10mm
2120010125	125mm for DN100	10mm
2120010150	150mm for DN100	10mm
2120010175	175mm for DN125	10mm
2120010200	200mm for DN150	10mm
2120010225	225mm for DN175	10mm
2120010250	250mm for DN200	10mm
2120012100	100mm for DN70	12mm
2120012125	125mm for DN100	12mm
2120012150	150mm for DN100	12mm
2120012175	175mm for DN125	12mm
2120012200	200mm for DN150	12mm
2120012225	225mm for DN175	12mm
2120012250	250mm for DN200	12mm
2120012275	275mm for DN225	12mm
2120012300	300mm for DN250	12mm
2120012350	350mm for DN300	12mm

## Delivery Hose Lube 0.95L

2110000003



To pre-lubricate inner surface of Coating Pump Delivery Hose to make pumping faster. If you find it difficult to push the brush/hose assembly through pipes with bends you can also apply a small amount to reduce pipe friction.

## Brush Stopper 8mm

900000338



Provides extra security to keep the Coating Brush on the shaft. Includes one Brush Stopper.

## Brush Stopper 12mm

900000756



Provides extra security to keep the Coating Brush on the shaft. Includes one Brush Stopper.



**NEW!**

## Xpress Static Mixing Tip

Product #	Part
2220300001	Static Mixing Tips & Y-Fitting Package
2220300006	Static Mixing Tip (10 pcs)
2220300007	Xpress Y-fitting for Mixing Tip

### Other Items Needed:

Drain Camera, Resin Cups, Duct Tape, Acetone Rags & Bucket with Lid, Nitrile Gloves, Razor Knife, 3, 5, 6mm Hex Keys.

# XPRESS SYSTEM | TROUBLESHOOTING FLOWCHART

SAVE ALL WARNINGS AND INSTRUCTIONS FOR FUTURE REFERENCE

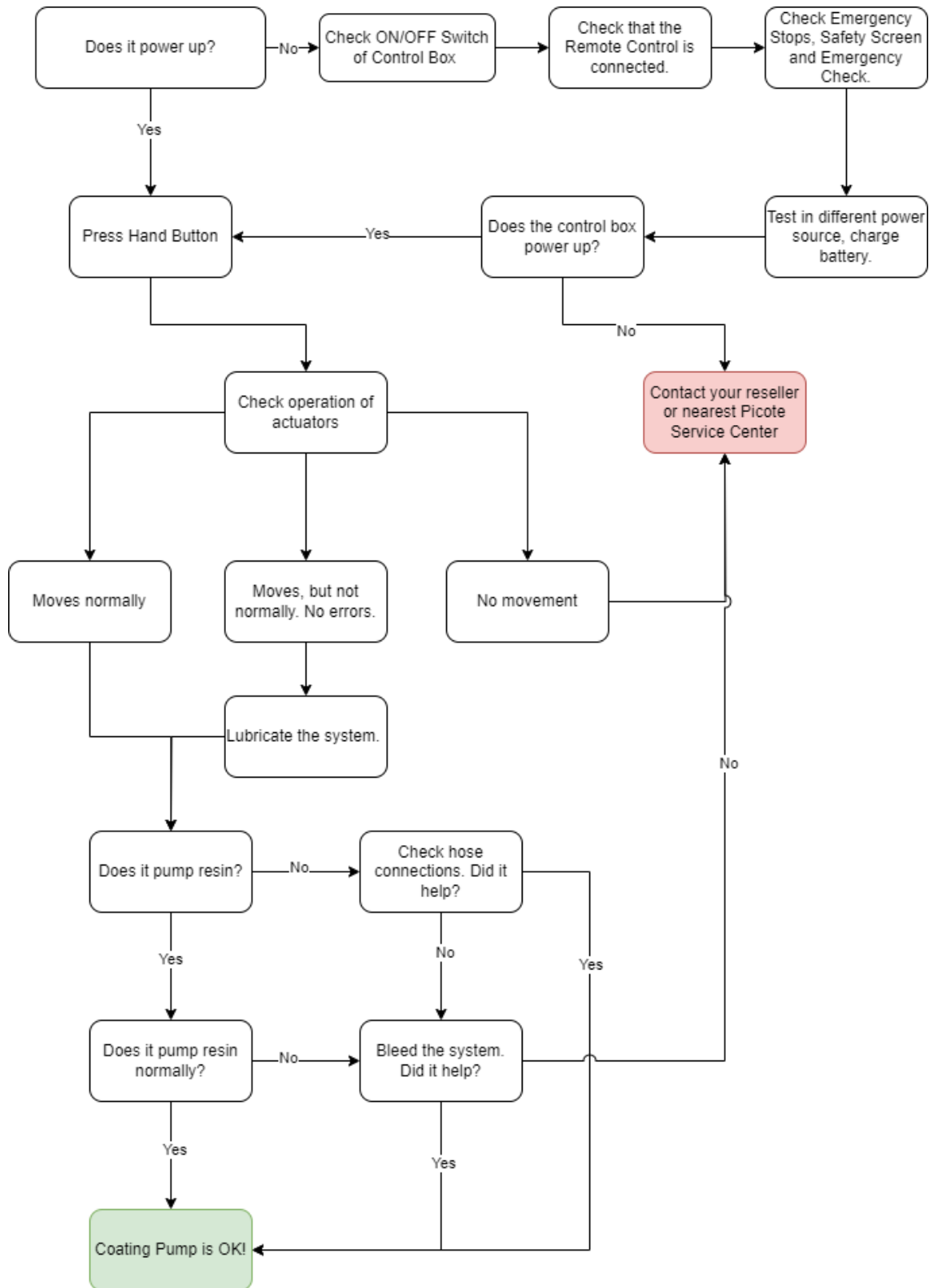

If there is problem that you cannot resolve with this manual, please consult your Picote Reseller or Picote Solutions at [claims@picotesolutions.com](mailto:claims@picotesolutions.com)

# TROUBLESHOOTING FAULT CODES

**SAVE ALL WARNINGS AND INSTRUCTIONS FOR FUTURE REFERENCE**

## TROUBLE SHOOTING

The control box of the Xpress Coating Pump will show fault codes according to different problems which the machine may encounter during use.

**Please check from the list below the most common fault codes of the control box. If a code other than those shown below is received, or if the fault does not correct, please write down the error code and contact your reseller or Picote Service Centre.**

Fault Code	Description	Suggested fix
Temperature Low	Actuator temperature too low	Let the machine warm up in room temperature. If the problem persists, contact Picote Solutions or your reseller.
Temperature High	Actuator temperature too high	Ambient temperature might be too high. Let the machine cool down. If the problem persists, contact Picote Solutions or your reseller.
Overload Flag	Actuator power limit	Actuator overload. Perform de-crystallization as instructed on Page 22. If the problem persists or becomes frequent, contact Picote Solutions or your reseller.
Backdrive Flag	Actuator movement without user command.	Avoid vibrating surfaces. Restart the system. If the problem persists, contact Picote Solutions or reseller.
Parameter Flag	Parameters not within specified range.	Parameter file might be corrupted. Contact Picote Solutions or reseller.
E-code 1	Communication error.	Check the error and continue working. If the problem persists, restart the system and connect the system to AC power. If the error comes back constantly, contact Picote Solutions or reseller.
Position Difference	Actuators out of sync.	Release the Start Button and press Check Button. Press Start Button again to level the actuators. If the problem persists, contact Picote Solutions or reseller.
Can Bus Connection		Restart the system. If the problem persists or comes back constantly, contact Picote Solutions or reseller.
Can Port 1 Failure	Actuator 1 CAN error	Restart the system. If the problem persists or comes back constantly, contact Picote Solutions or reseller.
Can Port 2 Failure	Actuator 2 CAN error	Restart the system. If the problem persists or comes back constantly, contact Picote Solutions or reseller.

# WARRANTY POLICY AND PROCEDURE

## SAVE ALL WARNINGS AND INSTRUCTIONS FOR FUTURE REFERENCE

### Limited Warranty:

Picote warrants to the original End User that the Product purchased by such End User will operate in accordance with, and substantially conform to their published specifications when shipped or otherwise delivered to the End User and for a period of one (1) year, except electric motors for which the warranty period shall be six (6) months, provided, however, that Picote does not warrant any claim or damage under this Warranty if such claim or damage results from:

1. Consumable parts or normal wear and tear resulting from use of the Products,
2. Product overload or overheated motor,
3. Regular periodic maintenance of Products,
4. Misuse, neglect, or improper installation or maintenance of the Products, or use of Products not for their intended purpose,
5. Products that have been altered, modified, repaired, opened or tampered with by anyone other than Picote or an authorized Picote Service Centre, or unsuitable or unauthorized spare parts, accessories or third party products when using the Products or;
6. the use of the Products not in compliance with their respective Documentation, user manuals, safety and maintenance instructions, and any usage restrictions contained therein, or
7. accident, fire, power failure, power surge, or other hazard.

Otherwise, the Products are sold AS IS. End User is responsible for using the Products within their specifications and instructions as contained in the Documentation.

**EXCEPT AS SPECIFIED IN THIS WARRANTY, ALL EXPRESS OR IMPLIED CONDITIONS, REPRESENTATIONS, AND WARRANTIES INCLUDING, WITHOUT LIMITATION, ANY IMPLIED WARRANTY OR CONDITION OF MERCHANTABILITY, FITNESS FOR A PARTICULAR PURPOSE, NON INFRINGEMENT, SATISFACTORY QUALITY OR ARISING FROM A COURSE OF DEALING, LAW, USAGE, OR TRADE PRACTICE, ARE HEREBY EXCLUDED TO THE EXTENT ALLOWED BY APPLICABLE LAW. TO THE EXTENT AN IMPLIED WARRANTY CANNOT BE EXCLUDED, SUCH WARRANTY IS LIMITED IN DURATION TO THE WARRANTY PERIOD. BECAUSE SOME STATES OR JURISDICTIONS DO NOT ALLOW LIMITATIONS ON HOW LONG AN IMPLIED WARRANTY LASTS, THE ABOVE LIMITATION MAY NOT APPLY. This disclaimer and exclusion shall apply even if the express warranty set forth above fails of its essential purpose.**

# TRAINING & CERTIFICATION

SAVE ALL WARNINGS AND INSTRUCTIONS FOR FUTURE REFERENCE

## TRAINING CENTRES:

- Phoenix, Arizona, **USA**
- Porvoo, **Finland**
- Sandhurst, England, **UK**



Picote Certified Installer Training for Picote Brush Coating™ is highly recommended to get the most out of your investment.

For Picote Brush Coating™ Certified Installer Training you will receive a Picote ID Card for completion (UK only), which can be used for the tendering process and on site.

Certificates are awarded for all certification trainings.

Visit our website at [www.picotegroup.com](http://www.picotegroup.com) or contact us at [training@picotesolutions.com](mailto:training@picotesolutions.com) to find out about course offerings, pricing, and scheduling.

## 10 YEAR WARRANTY\*

When using the Picote Brush Coating™ System as an option for semi-structural pipe rehabilitation you are providing a solution that can last 30-50 years. When you successfully complete Picote Certified Installer Training for Picote Xpress Coating System you will be able to offer a 10 year warranty on the Picote 100% Solids Epoxy Resin when you meet the outlined criteria. This provides assurance for the end-user as well as an advantage when you tender for work.

\*Terms & conditions apply, ask for details.



**International Offices**  
Finland. United Kingdom. USA.

**E-Learning**  
Free E-learning courses, videos, guides, catalogs and more are available at:  
[www.picoteinstitute.com](http://www.picoteinstitute.com)

**Technical Support**  
[support@picotesolutions.com](mailto:support@picotesolutions.com)

**Authorised Resellers:**  
[www.picotesgroup.com/resellers](http://www.picotesgroup.com/resellers)

**Production & R&D**  
Pienteollisuustie 24  
06450 Porvoo, Finland  
[support@picotesolutions.com](mailto:support@picotesolutions.com)

**Claims**  
[claims@picotesolutions.com](mailto:claims@picotesolutions.com)

[www.picotegroup.com](http://www.picotegroup.com)  
[www.picoteinstitute.com](http://www.picoteinstitute.com)